

# SPECTRUM Bass



operation manual

STYLING

REVIEWS



Intended to alert the user to the presence of uninsulated "dangerous voltage" within the product's enclosure that may be of sufficient magnitude to constitute a risk of electric shock to persons.



Intended to alert the user of the presence of important operating and maintenance (servicing) instructions in the literature accompanying the product.

**CAUTION:** Risk of electrical shock – DO NOT OPEN!

**CAUTION:** To reduce the risk of electric shock, do not remove cover. No user serviceable parts inside. Refer servicing to qualified service personnel.

**WARNING:** To prevent electrical shock or fire hazard, do not expose this appliance to rain or moisture. Before using this appliance, read the operating guide for further warnings.

# Contents

QUICK START .....	2
ABOUT THIS MANUAL .....	4
<b>Chapter 1 Introduction .....</b>	<b>5</b>
FEATURES .....	5
<b>Chapter 2 Overview .....</b>	<b>6</b>
THE FRONT PANEL .....	6
THE BACK PANEL .....	6
GETTING TO KNOW YOUR BASS II .....	7
<b>Chapter 3 Connections .....</b>	<b>8</b>
SETUP .....	8
CONNECTIONS .....	9
<b>Chapter 4 Basic Operation .....</b>	<b>12</b>
TERMS YOU SHOULD KNOW .....	12
MIDI MODES AND MULTI SETUP .....	12
CONTROLLER USAGE .....	13
GLOBAL BEND RANGE (PRG, 0-24) .....	14
PRESET CONTROL .....	14
AUTOFLOW .....	14
REINITIALIZATION .....	14
<b>Chapter 5 Beyond the Basics .....</b>	<b>15</b>
DID YOU KNOW .....	15
HOW SOUND IS GENERATED .....	15
The Spectrum Bass II Synthesizer Architecture .....	15
Oscillators .....	16
Wave Start Offset .....	16
Oscillator Sync .....	16
DCAs .....	17
Pan .....	17
Filters .....	17
MODULATION AND THE SPECTRUM BASS II .....	18
Keyboard Scaling .....	19
Sample and Hold .....	19
Portamento .....	20
Low Frequency Oscillator (LFO) .....	21
Envelopes .....	21
MODULATION SOURCES/SAMPLE AND HOLD INPUT SOURCES .....	22
WAVEFORM REFERENCE LIST .....	22
<b>Chapter 6 Advanced use with a PC 1600 .....</b>	<b>23</b>
Patch Editing Descriptions .....	24
<b>Appendix A MIDI Implementation .....</b>	<b>26</b>
<b>Appendix B Parameters Saved on Power Down .....</b>	<b>27</b>
<b>Appendix C System Exclusive .....</b>	<b>28</b>

## QUICK START

Hey, we know not everyone likes to read manuals or even needs to read manuals, that's why we are providing this quick start section. We want to make using your new Peavey equipment an easy, enjoyable experience.

### ▼ To get started quickly

1. The first thing you need to do is to connect the Spectrum Bass II to your system configuration. Here are some things to check first:
  - ⌚ Make sure your amplification system is turned off.
  - ⌚ Turn the Spectrum Bass II's **Volume** knob fully counterclockwise.
  - ⌚ Plug the MIDI Out from your keyboard to the MIDI In on the Spectrum Bass II.
  - ⌚ Connect the mono/right audio output of the Spectrum Bass II to the input of your keyboard amplifier. (If possible use a stereo connection; you won't be disappointed. Connect the left and right audio outputs to your amplification system with mono cables or use a stereo cable connected to the stereo/left audio output.)
  - ⌚ Connect the power jack of the Spectrum Bass II to an electrical outlet using the 16-16.5 volt AC 1000 mA adapter provided.
  - ⌚ Turn on your amplifier.
  - ⌚ See the diagram below.

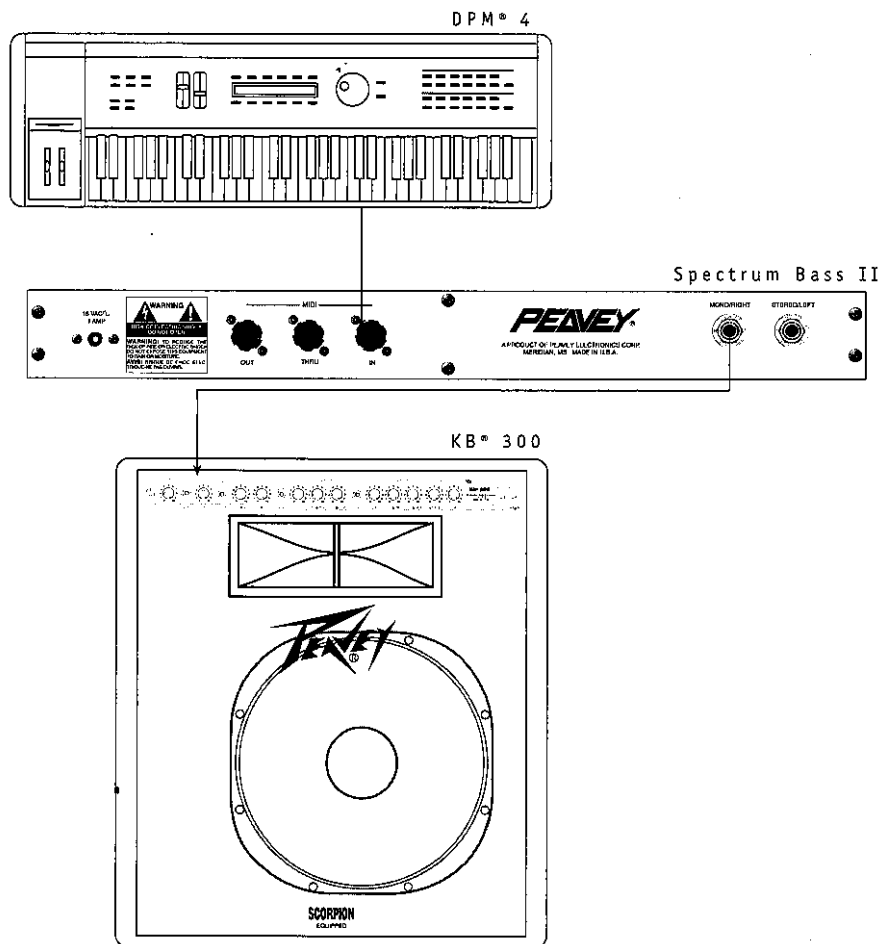

2. It is now necessary to properly set up your Spectrum Bass II to send and receive MIDI information. To do this:

*Setting the MIDI Mode*

- ⌘ Press the button labeled **Mode** until the **Poly** LED lights. This puts you into poly mode. The poly mode allows you to send and receive MIDI data on one channel only.

*Setting the MIDI Channel*

- ⌘ Press and hold the button labeled **Channel**; while holding this button, press the ▲ or ▼ button until the MIDI receive channel for the Spectrum Bass II matches the MIDI transmit channel of your keyboard. If in doubt, try channel 1.

3. Okay. Now it's time to play.

- ⌘ Start playing your keyboard; as you play, turn the Spectrum Bass II's **Volume** knob clockwise until you reach the desired volume.
- ⌘ The Spectrum Bass II's display will show the current patch number. To select a different patch, use the ▲ and ▼ buttons.

4. That's it!

## **ABOUT THIS MANUAL**

Can it be? We thought that nobody ever read manuals anymore! Since we seem to be mistaken in our belief that nobody reads manuals, we should probably give you some information that is useful. We'll even try to present it in an interesting manner (won't that be unusual).

This manual covers several distinct sections. These sections are arranged in the same manner that a user may want to learn them.

We have provided a Quick Start section, in case you suddenly decide that you don't really want to read the manual. Here is a brief description of what can be found in each section.

Chapter 1, **Intro**, provides a brief introduction to the Spectrum Bass II along with the Quick Start guide.

Chapter 2, **Overview**, provides a quick overview of the front and back panels of the Spectrum Bass II.

Chapter 3, **Connections**, shows some of the more common connection schemes for the Spectrum Bass II.

Chapter 4, **Basic Operation**, provides you with some of the more basic knowledge needed to use the Spectrum Bass II, such as: setting the MIDI channel, selecting the MIDI mode, change patches and tuning the unit.

Chapter 5, **Beyond the Basics**, explains some basic synthesis information as used by the Spectrum Bass II.

Chapter 6, **Advanced Operation**, provides power users with the information they need to interact with the Peavey PC™ 1600.

Appendix A, **MIDI Implementation**, is a chart showing the MIDI implementation that the Spectrum Bass II provides.

Appendix B, **Parameter Saved on Power Down**, provides a list of parameter settings saved when power is turned off.

Appendix C, **SysEx**, provides system exclusive formats.

# Chapter 1 Introduction

Congratulations and thank you for purchasing the Spectrum™ Bass II. The Spectrum Bass II was designed to offer the ultimate in bass sounds to the user. The sounds range from smooth flowing fretless to nasty synth basses in 16-bit resolution (24-bit internal), full MIDI compatibility, 24 oscillators, 12-voice polyphony, and 6-part multi-timbral capability.

The Spectrum Bass II features classic bass waves, digital bass waves, and a selection of 4 and 5 string bass waves. Couple this with Peavey's dynamically modulated resonant filters and the results can range from realistic to totally tortured, screaming sounds.

The Spectrum Bass II was designed to answer the need for bass synthesizer sounds in a package with current MIDI technology and state-of-the-art synthesizer capabilities.

## FEATURES

- 2 MB 16-bit acoustic, classic analog and digital bass waveforms
- 256 presets; 192 ROM/64 RAM
- 24 oscillators (2 oscillators per voice)
- 12-voice polyphony
- 6-part multi-timbral
- Hard Sync
- 12 dynamically modulated resonant filters
- Portamento
- Sample and Hold
- AHDSR envelopes for a classic feel
- Custom patches for the Peavey PC™ 1600 MIDI Controller ready to be downloaded from the Spectrum Bass II
- Digital display of:
  - ▾ Program number
  - ▾ Fine tune
  - ▾ Transpose
  - ▾ Pitch bend range
  - ▾ MIDI channel
  - ▾ MIDI receive acknowledge
  - ▾ Number of channels recognized in multi mode
  - ▾ Autoflow enable

# Chapter 2 Overview

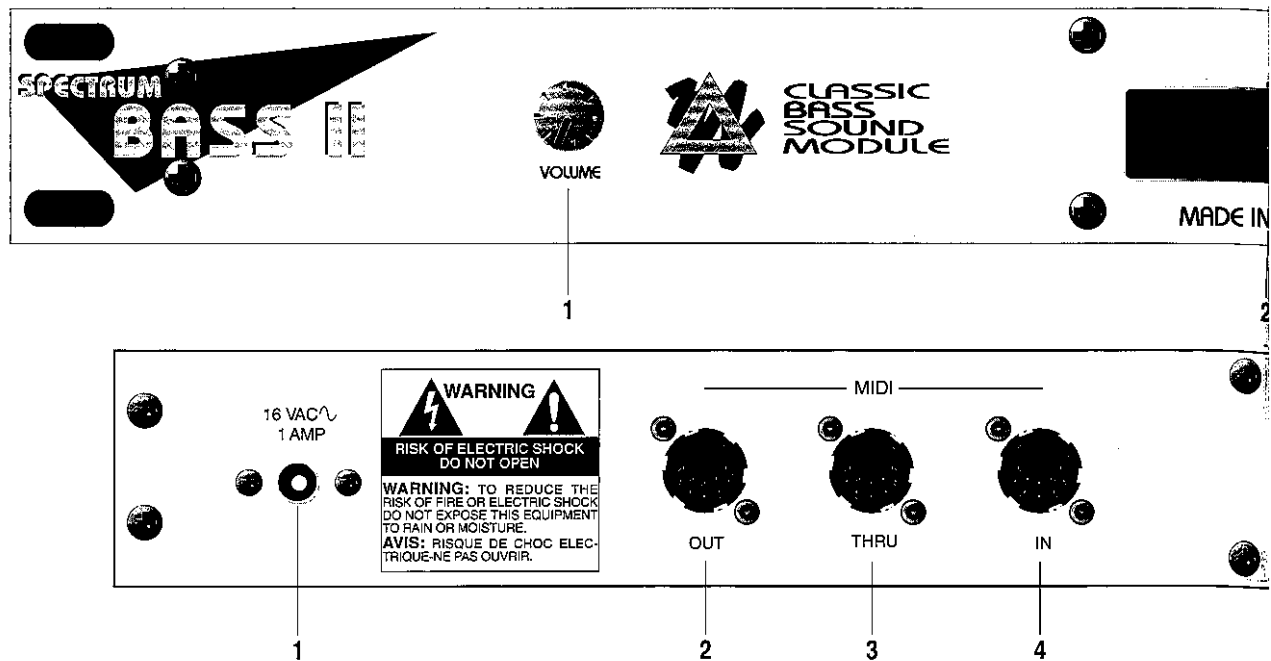

## THE FRONT PANEL

### 1. Volume Knob

The **Volume** knob adjusts the overall volume of the Spectrum Bass II.

### 2. LED Display

This is a three-digit, seven-segment display.

### 3. Up and Down Arrow Buttons (▼ and ▲)

These buttons are used to inc/dec through programs and to edit parameters.

### 4. Channel Button

The **Channel** button is used to select the MIDI receive channel. Channels 1-16 are available.

### 5. Transpose Button

The **Transpose** button is used to adjust the pitch. The Spectrum Bass II may be transposed any number of semitones to  $\pm 2$  octaves.

### 6. Fine Button

The Fine button is used to perform fine tune adjustments to the pitch. The range is  $\pm 99$  cents.

### 7. Mode Select Button/LEDs

The **Mode Select** button is used to select the MIDI mode. There are six choices available: Omni, Poly, Multi, Legato, Poly-Legato, and Multi-Legato. It is also used to edit the number of MIDI channels the unit will respond to in multi-timbral mode.

## THE BACK PANEL

### 1. Power Jack

Use only the 16-16.5 volt AC 1000 mA adaptor provided. (Peavey Part #00710160)

**Caution:** Use only the Peavey 16-16.5 volt power supply provided with this product. If the original power supply must be replaced, consult your Peavey dealer or the factory for the correct replacement. Failure to use



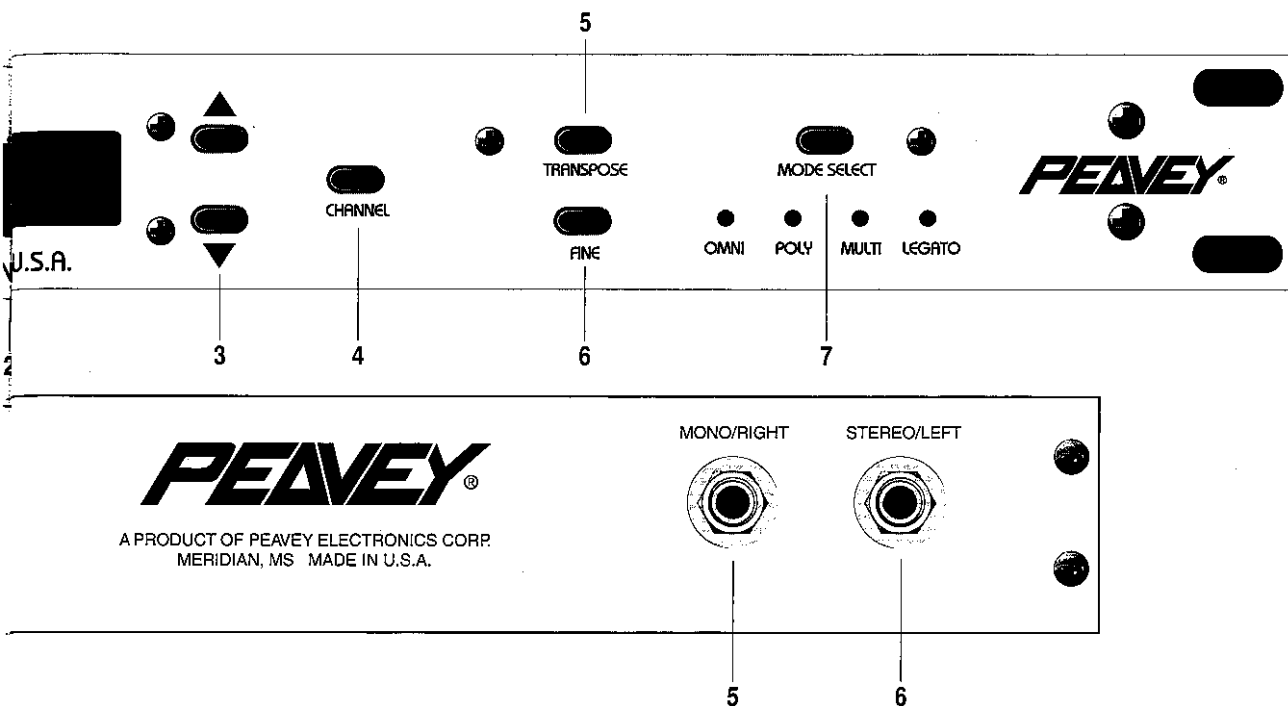

the correct power supply could result in fire, shock hazard, extensive circuit damage, decreased performance, or non-operation.

## 2. MIDI Out Jack

This is a standard 5-pin DIN jack used for sending MIDI overflow data and/or SysEx data from the Spectrum Bass II to receiving unit(s).

## 3. MIDI Thru Jack

This is a standard 5-pin jack used to echo MIDI data received at the MIDI In jack. This means that the receiving unit(s) will receive an exact copy of the MIDI data the Spectrum Bass II received.

## 4. MIDI In Jack

This is a standard 5-pin jack used for receiving MIDI data from the sending unit.

## 5. Mono/Right Jack

This is a standard 1/4" mono output jack. The output from this jack is the Right channel *if* a plug is inserted into the Stereo/Left jack and is the summed Left and Right channels *if* no plug is inserted into the Stereo/Left jack.

## 6. Stereo/Left Jack

This is a standard 1/4" stereo output jack. The output from this jack is stereo when used with a stereo cable, with the Left channel on the tip, and the Right channel on the ring.

Throughout the rest of the manual we will refer to the Spectrum Bass II as the Bass II.

## GETTING TO KNOW YOUR BASS II

It's pretty simple to tell when the Bass II is turned on; when it's plugged in it should be on.

Using the Bass II is nearly as easy. The following sections provide information on: connecting the Bass II, sound editing, front panel editing, MIDI modes and Multi setups, controller usage, autoflow, and of course the ever popular MIDI implementation and system exclusive appendices. Enjoy!

# Chapter 3      Connections

## SETUP

When you power up the Bass II for the first time, you should see the program LED display come to life. In the display will be three numbers, i.e., **001**. This represents the current preset (or patch) number. Once you have connected the Bass II to your MIDI keyboard (either using the diagrams in this chapter or the Quick Start guide) you should set the MIDI receive channel. Set the MIDI receive channel by pressing and holding the button labeled Channel, then use the ▼ or ▲ button to move to the desired channel. You probably want to set the MIDI mode as well. To do this, press and release the Mode Select button until the LED above the desired mode is lit. If you are unsure which mode you want, try using OMNI. For a more complete description of the MIDI modes see Chapter 4.

The rear panel consists of your stereo/mono outputs and MIDI In, Out and Thru jacks, and power input jacks.

To see if MIDI is being received, send MIDI data (notes, mod. wheel, etc); there should be a little dot in the bottom right corner of the LED display showing the reception of any MIDI data.

## CONNECTIONS

This chapter shows a couple of the more common connection schemes.

### 1. Basic Connection (keyboard)

The following diagram represents what might be considered a “typical” keyboard setup. In this connection we have included the DPM® 4 keyboard, Spectrum Bass II, and KB® 300 keyboard amplifier.

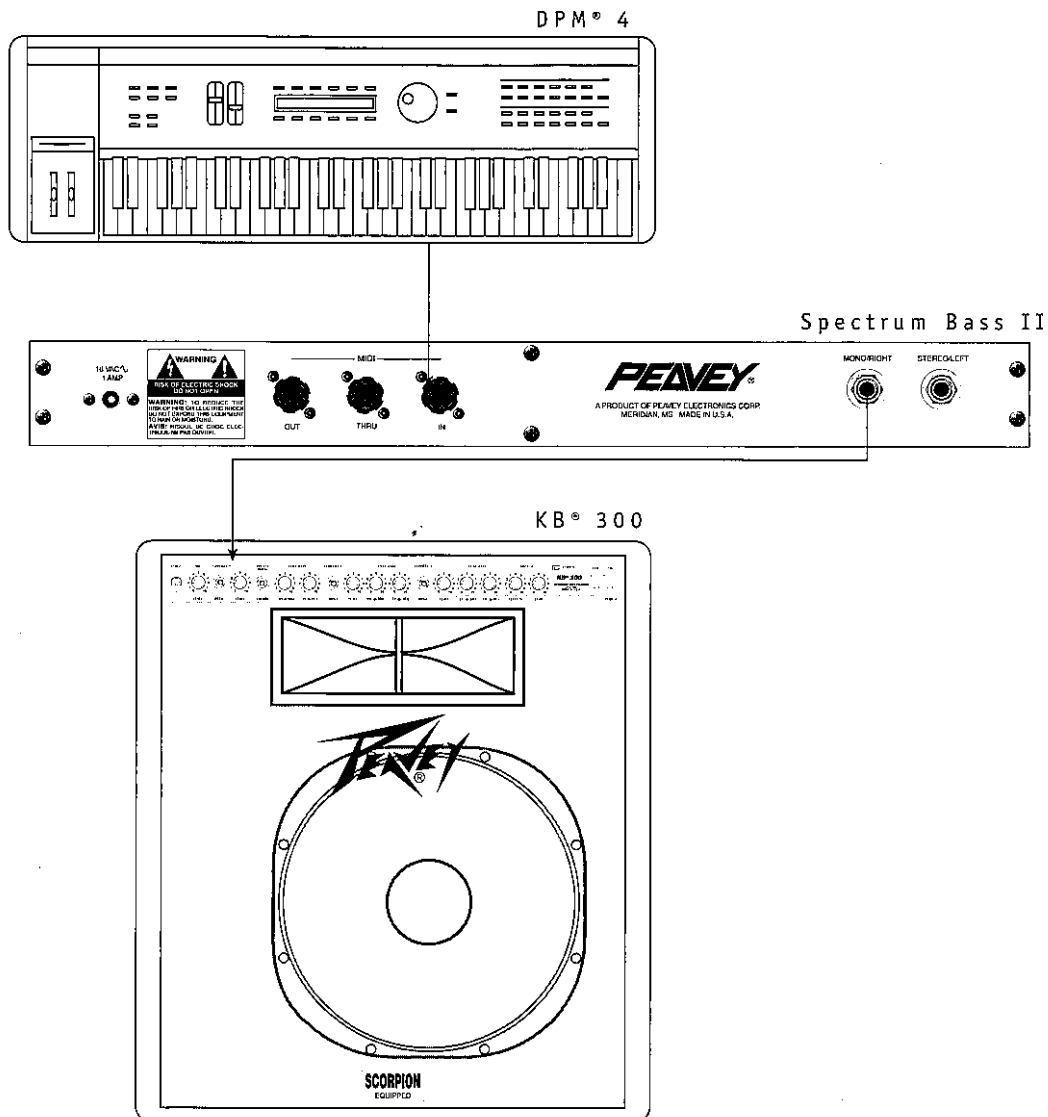

## 2. Basic Connection (bass guitar)

The following diagram represents what might be considered a “typical” bass setup. In this connection we have included the Cyberbass bass guitar, Spectrum Bass II, DPC™ 1000 amplifier and speaker.

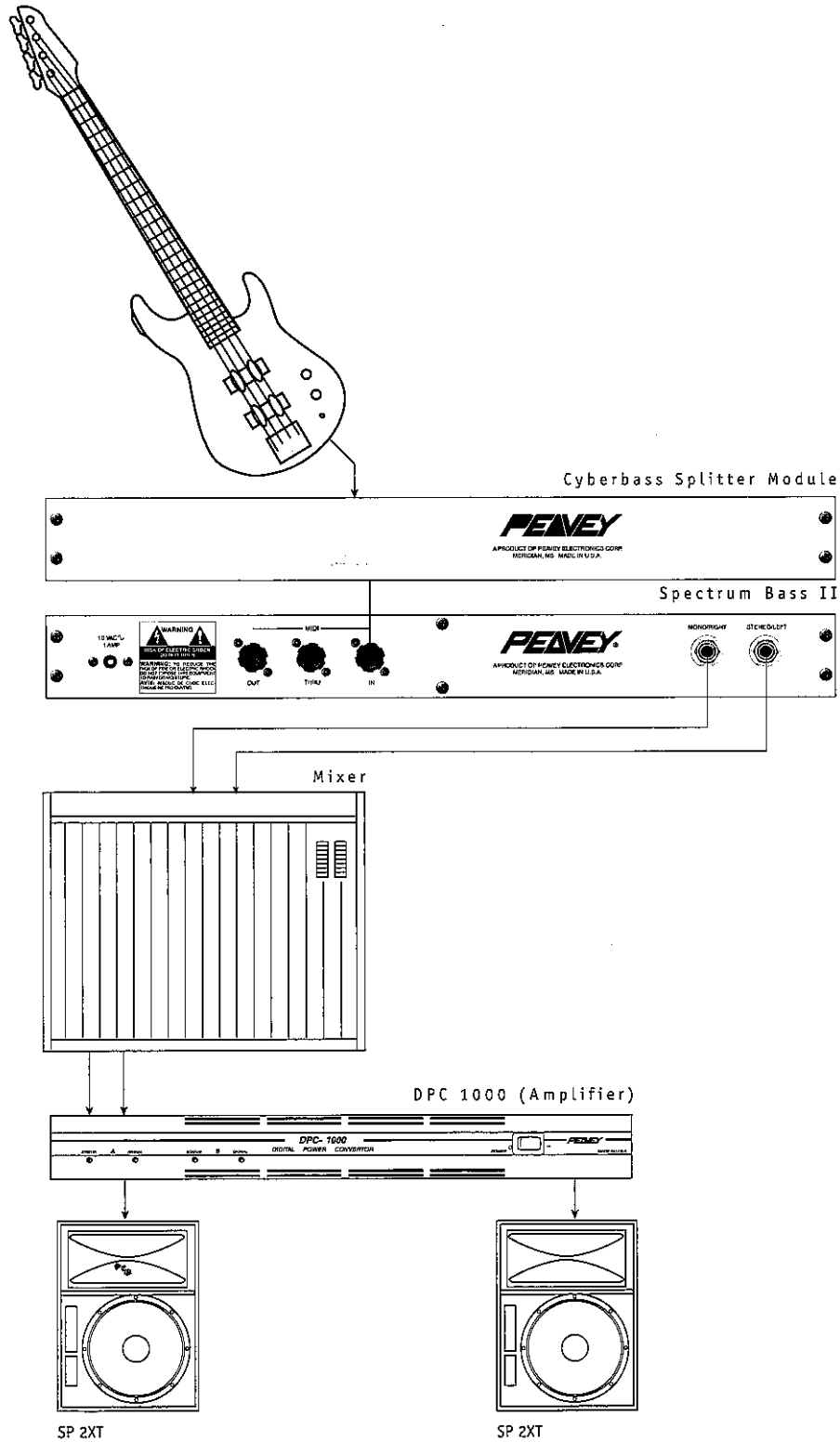

### 3. Advanced Connection

In this diagram, we have taken a DPM C8p master controller keyboard and connected it to a PC 1600 MIDI controller. We use this to provide sophisticated patch creating/editing capabilities. To this we have added two Spectrum Bass II modules; the second is used to automatically catch and play any overflowed notes. Next, we add an amplification system that includes a mixer (this allows you to connect audio outputs from both Bass II's). The mixer is connected to a DPC 1000 digital amplifier and a pair of SP™ 2XT speaker enclosures. Of course everything represented here is made by Peavey and should be readily available at your local dealer.

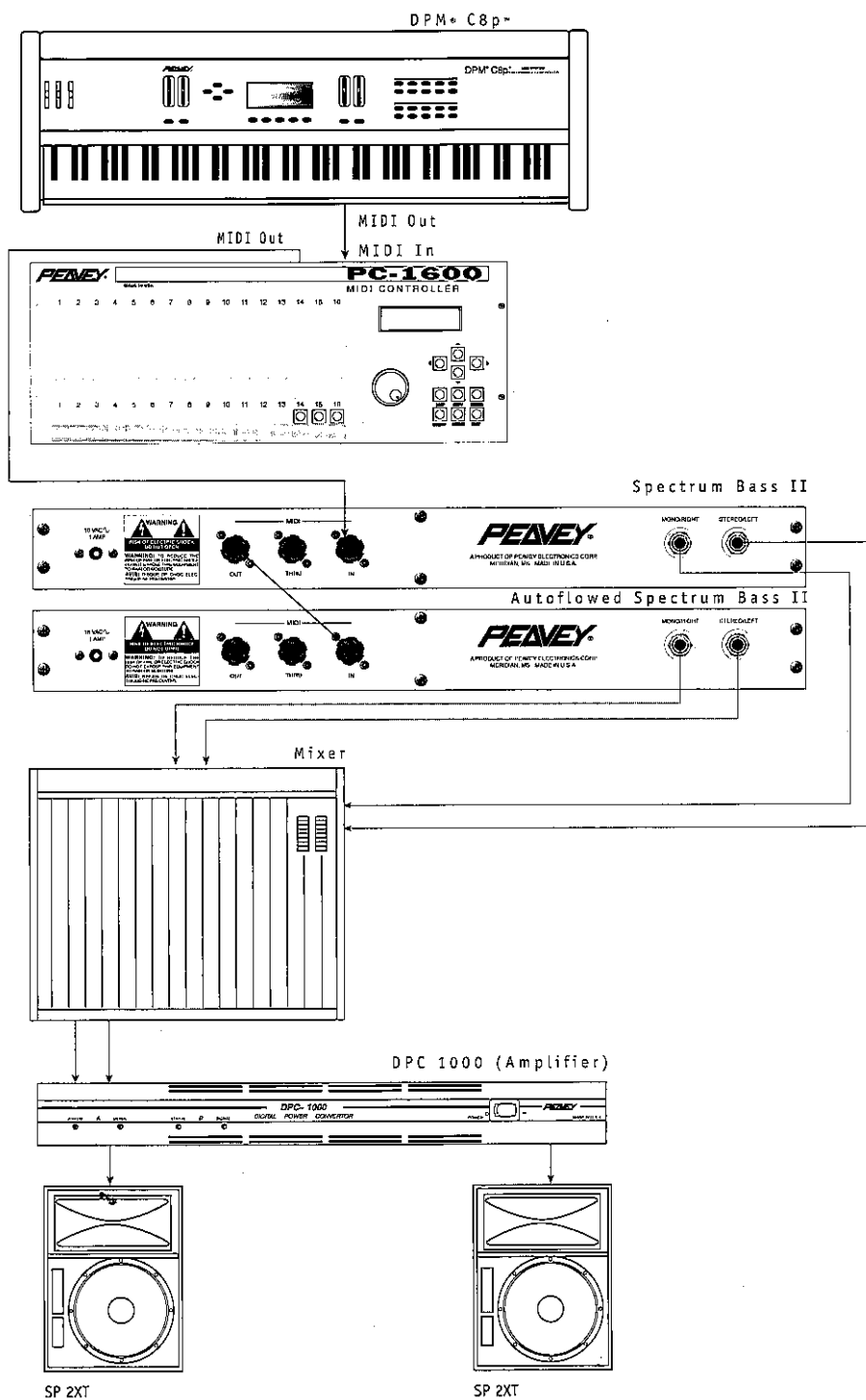

# Chapter 4 Basic Operation

## TERMS YOU SHOULD KNOW...

- Legato* - A smooth and unbroken transition between successive notes.
- Multi-timbral* - More than one distinct preset may sound at a time.
- Polyphonic* - The simultaneous combination of two or more sounds.
- Portamento* - The pitch glides between notes.
- Preset* - A storage location for all parameters pertaining to a sound.
- Voice* - The sound that is playing. If something is 4-voice, it means that four sounds can be playing simultaneously.
- Waveform* - A wave (e.g., sine or sawtooth) that is used to create the sounds (voices) generated.

## MIDI MODES AND MULTI SETUP

The Mode Select button (when pressed and released quickly) will advance you through all the possible MIDI modes and variations that the Bass II is capable of. This selector will wrap around when advanced past the last selection. The MIDI specification allows for four modes: Omni, Poly, Mono, and Multi. The Bass II adheres to the MIDI specification for these modes but also allows for some new and innovative variations, as far as legato playing is concerned.

The Bass II is up to 6-part multi-timbral. However, you may need less than six parts from the Bass II, but need the other channels to drive other modules. In this case, you can tell the Bass II how many parts (channels) it should respond to while in its MULTI, LEGATO or MULTI/LEGATO modes. (Adjustable from 2-6, in continuous order starting at the MIDI receive channel).

As mentioned above, the MODE SELECT button will change the MIDI mode if pressed and immediately released (mode changes on release). When it is first pressed down, the LED display will show the number of MIDI channels the Bass II will respond to in the MULTI, LEGATO, and MULTI/LEGATO modes. The choices will be 2-6 (defaulting to 6 when the unit is initialized). This value can be edited with the ▲ and ▼ buttons while the MODE SELECT button is held. In this case, the release of the button will not cause a mode change. Also, if the MODE SELECT button is pressed and held for more than one second, the Bass II assumes that you wanted to see the number of channels on the LED and not change the mode. Therefore, in this case the release of the button will not change the mode.

The Legato mode selection will occupy 2-6 channels, each channel playing the same preset in a legato fashion. The selection of these channels is the same as just described below for the Multi mode. This mode is normally used with a guitar or synth MIDI controller (the Peavey CyberBass, for instance), with each string sending MIDI data on a separate channel.

If legato style playing is desired, yet you don't want to burn extra MIDI channels in the process, advance the Mode Select button until both the *Poly* and *Legato* LEDs are on. This setting will behave as in straight poly mode except for the allocation of voices (only one voice sounds). A word here on legato footswitch controller (controller #68): The legato footswitch controller is a newly ratified addition to the MIDI controller list, which will toggle the playing mode between normal and legato (see side bar for explanation of legato playing style). Certain patches will override the front panel setting and force legato on or off upon recall. Neither this, nor the controller will affect the Legato LED.

The Bass II responds to this controller and can be used in the Poly and Multi modes to switch to legato playing style. So, say for instance you are playing in Poly mode, and you send the Bass II a Legato footswitch message. The Bass II will now behave as though you had selected the Poly-Legato mode with the Mode Select button (although the LED status will still indicate just Poly). Sending a Legato footswitch message below threshold will bring you back into normal playing. This is much more versatile and expressive than a straight Legato mode allows for.

Now, the same sort of playing styles are possible in Multi mode. Advancing the Mode Select button until both the *Multi* and *Legato* LEDs are on will yield a MIDI Multi mode (2-6 channels, each capable of a distinct preset) but with each channel playing in legato fashion. If you happen to be in straight Multi mode and you send the Bass II a Legato footswitch message above the threshold value, that channel will then switch to a legato playing style. This allows for a mixture of channels playing legato and normal, with the ability to switch back and forth on any of the six channels in real time.

The Multi preset selections roll with the MIDI channel selection. Let's take a second to explain this: If the MIDI channel currently selected is 1, then the Bass II will respond multi-timbrally on channels 1-6 (if the number of channels is set to 6—the maximum). A channel will play whichever preset was selected as a result of a program change message. The Bass II is initialized at the factory to play presets 1-6. Now, changing the MIDI channel to channel 2, for instance, causes Multi response to shift to channels 2-7; BUT, the preset selections remain the same. So, assuming the factory preset described above, if the MIDI channel is set to 2, channel 2 will play preset 1, channel 3 will play preset 2, and so on. This a convenient way to accommodate altering your MIDI setup without having to change presets on each channel.

The last presets sent to each channel are saved at power down and are available immediately at power up. Also, the current MIDI mode is saved at power down.

## **CONTROLLER USAGE**

The Bass II responds to several MIDI controller messages, adding a variety of expression not normally achieved with a sample playback device.

If your controller lacks the ability to transmit some of these messages, check out the Peavey PC 1600, which can transmit any controller on sixteen separate sliders, as well as perform real time MIDI mixdown and Sysex control.

In addition to the usual mod wheel, aftertouch, and sustain messages, the Bass II responds to the following controllers:

- *Volume Controller (#7)*

This can be used to control the volume via MIDI, either for overall level control as in Poly mode, or to mix the levels of the six channels comprising the Multi.

- *Pan Controller (#10)*

This can be used to control the stereo placement of presets as follows:

Values 0-63 will result in placement from hard left to just left of center.

Values 64-127 will result in placement from center to hard right.

This can be used for a set and forget fixed value stereo placement, or in a real time pan sweep.

- *Legato Footswitch Controller (#68)*

This controller is used to switch the playing style between normal and legato as follows:

Values 0-63 will result in normal playing style.

Values 64-127 will result in legato playing style.

See the section on MIDI Modes for more discussion on legato playing.

## **GLOBAL BEND RANGE (PRG, 0-24)**

The pitch bend range used by the Bass II normally comes from each patch (powerup default). You can, however, use this global override so that the bend range is constant for all patches. To see the bend range, press and hold **Transpose**, then press **Fine**. At this point, the number can be edited with the ▼ and ▲ buttons. (e.g., Prg = use patch info, 0 = off, 24 = 2 octaves, etc.)

## **PRESET CONTROL**

Use the ▼ and ▲ buttons to select a preset. When you power down, the last preset will return on power up. To increase the scrolling speed, press both the ▼ and ▲ buttons. For instance, to scroll up faster first press the ▲ button then press the ▼ button.

## **AUTOFLOW**

Autoflow provides a simple and instant way to configure a second Bass II module for overflow purposes. When a MIDI cable is connected from the MIDI Out of the first unit to the MIDI In of the second, overflow status is automatically detected. Autoflow will cause the first unit in the chain to send out Note On and other events to the second unit when the maximum polyphony (12 voices) has been exceeded.

Autoflow mode is intended to work with additional Bass II modules which have the same configuration as the first in the chain—channel, MIDI Mode, Multi presets, etc. Using Autoflow with any other MIDI tone module may not produce the expected results.

**Note:** If the Bass II's MIDI output is connected to something other than another Bass II (like a MIDI patchbay or librarian), you will want to disable the Autoflow feature so notes that you play are not sent over MIDI and “ignored” by the unit on the other end. Press and hold **Transpose**, then press **Channel** to see the Autoflow enable status. Switch it between “on” and “off” with the ▼ and ▲ buttons.

## **REINITIALIZATION**

This operation restores the factory default settings and patches, erases any RAM patches, and erases any edits you have made. Initialization is used as a service procedure. Sometimes microprocessor controlled devices will “lock up” due to spikes on the AC line, a static electricity jolt, or other gremlins. Initialization will reset the unit and in many cases, prevent a trip to the repair shop. The Spectrum Bass II can be reinitialized using the following procedure:

▼ To reinitialize

1. Press and hold the ▼ and ▲ buttons while applying power to the unit. The display will read “ini” for a short time while initializing.



# Chapter 5 Beyond the Basics

Not everyone wants or even needs to learn to program their synth modules; in a way programming a synth module is an art unto itself. As such, it is not possible to learn everything you need to know in a short period of time or from one “tell all” source, instead it may take years of experimenting to achieve the expertise you may desire. What we will try to do in this chapter is provide some background information on modulation, oscillators, etc. In addition, we will list the various patches and controllable parameters available when you use the Spectrum Bass II with a PC 1600 MIDI Controller. While it is possible to control these same parameters using various computer software programs and the system exclusive section of this manual, using the PC 1600 is easier since we have taken the time to develop the necessary sysex strings required to control the Bass II. Either way, we’re sure you’ll find the Spectrum Bass II a very versatile and extremely powerful tool for creating those special bass sounds you seek.

## ***DID YOU KNOW...***

Early synthesizers consisted of various hardware modules, some of which generated signals, and some of which modified those signals. To create as general-purpose a device as possible, patch cords connected the inputs and outputs of the various signal generating and processing modules (which is why particular synth sounds were called patches). Changing a patch involved manually repositioning patch cords and adjusting knobs and switches; recreating a patch at some later time required writing down all the patch settings on paper so they could be duplicated later. Even then, due to the vagaries of analog electronics, the patch might not sound exactly the same.

Over the years, certain combinations of modules seemed to work better than others, and since patch cords were troublesome to deal with, eventually these modules were wired together in a “normalized” configuration. Synthesizers such as the Minimoog, Prophet-5, and others eliminated the need for patch cords by containing a normalized collection of sound modules.

## ***HOW SOUND IS GENERATED***

### ***The Spectrum Bass II Synthesizer Architecture***

The following figure shows the signal flow for a two or four wave voice (total of twelve or six voices, respectively).

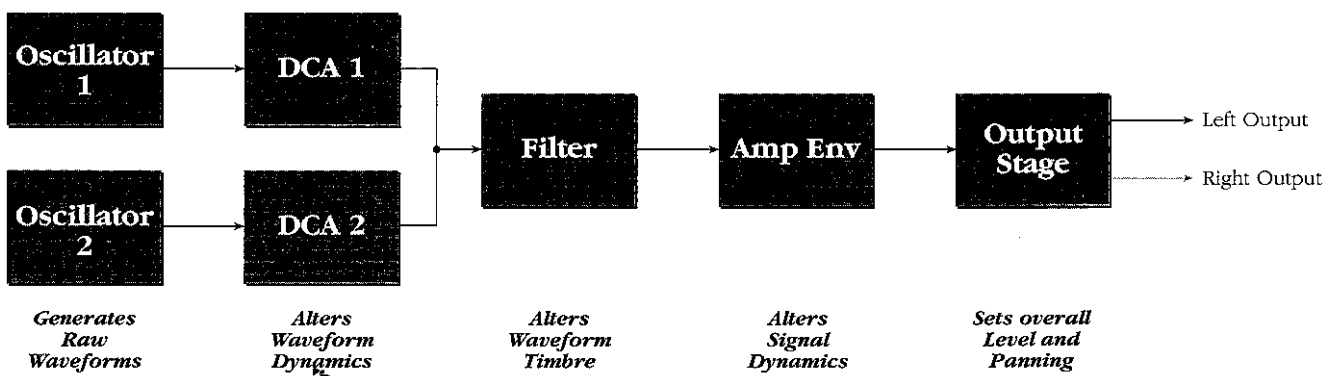

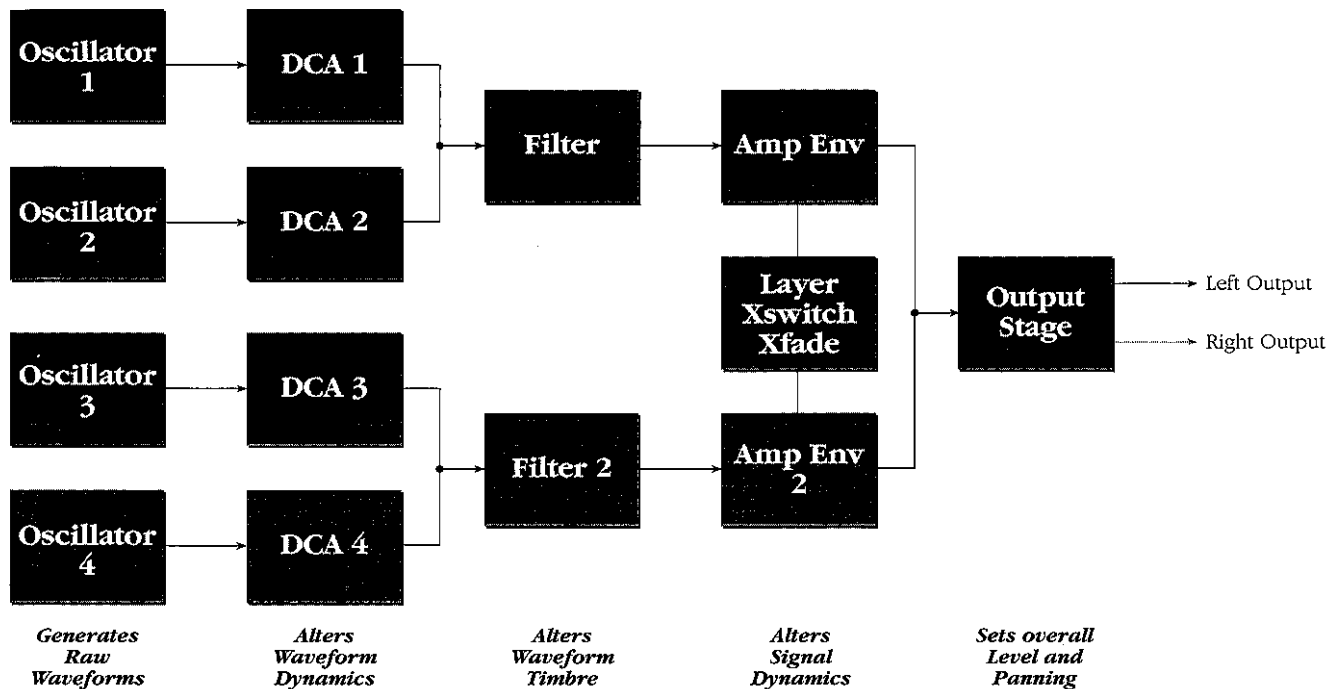

## Oscillators

The four digital oscillators (OSC1 through OSC4) provide the actual raw sounds, called *waves*. These can draw from any of the 78 on-board wavesamples. Each oscillator allows for adjustable wave pitch and modulation. Modulation is the process of varying a parameter dynamically over time; with the oscillators, the pitch can be modulated by various control sources, as described later.

Five oscillator combinations are possible:

- Oscillators 1 and 2
- Oscillators 3 and 4
- All four oscillators layered (limits the polyphony to 6 notes)
- Oscillator pairs cross switch (uses all four oscillators with a switch point to cross from the first pair to the second).
- Oscillator pairs crossfade (uses all four oscillators with a switch point to crossfade from the first pair to the second).

### Wave Start Offset

Each waveform is divided into 128 potential start points. By changing the start point, it is possible to change the phase relationship between two waves.

### Oscillator Sync

Oscillator Sync **ON** allows two oscillators which are tuned fairly close to be “synced” or locked together in pitch. To achieve a very cool effect, change the pitch of the second oscillator. This will cause the second oscillator’s pitch to produce successive harmonics of oscillator one’s fundamental. Give it a try...you’ll love it.

## DCAs

Each oscillator is followed by a DCA, which can modulate the level of the wave either statically (you set a particular volume level) or dynamically (the level changes over time in a specific way).

Having four DCA's allows for, among other effects, cross-fades between the four oscillators. *Example:* One DCA could fade out a flute sound while the other DCA fades in a synth waveform to create a synth flute sound.

The "Amp Env" is a DCA that follows the filter. The ampenv generally sets the overall dynamics.

## Pan

This sets the panning modulation of an oscillator pair and sends it to the audio outputs.

## Filters

This is a 2 or 4 pole "analog-sounding" filter with resonance. There is one filter for each oscillator pair. This can be:

- 0** - *2 pole Low Pass* Passes the frequencies up to the Cutoff point.
- 1** - *4 pole Low Pass* Passes the frequencies up to the Cutoff point with a steeper cutoff rate.
- 2** - *Band Pass* Passes only a narrow band of frequencies.
- 3** - *High Pass* Passes the frequencies above the Cutoff point.

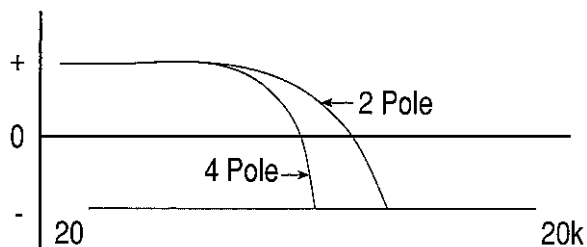

Low Pass

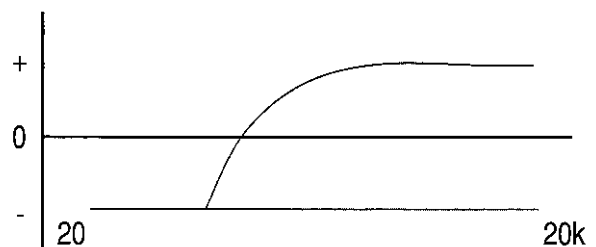

High Pass

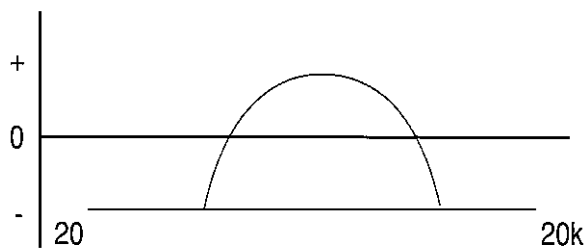

Band Pass

## MODULATION AND THE SPECTRUM BASS II

Modulation modifies some aspect of a sound over a period of time. Since synthesizers inherently make static sounds (unlike acoustic instruments, whose timbre and dynamics change—often radically—over the duration of a note), modulation can be the key to making rich and expressive sounds. The Bass II has a variety of modulation sources, shown in the chart on page 22. Here's an overview of the main modulation categories.

- Modulation signals generated by the way you play the keyboard or other controller driving the Bass II (velocity, note position, and pressure)
- Envelope generators (these produce a programmable modulation change over time)
- LFOs (these produce periodic, cyclic modulation changes over time, such as vibrato or tremolo)
- Performance controls (modulation wheel, foot pedal, and data slider, which are designed to be manipulated in real time, as you play)
- External MIDI control. This allows external MIDI control signals (e.g., from a sequencer) to control some aspect of the Bass II's sound.

The Bass II arranges its modulation source outputs and modulation destination inputs into a “matrix” so that virtually any output can feed virtually any input. The Wave, DCA, Filter, and Pan modules have two independent inputs that can be assigned to any modulation source. The LFO has one independent input that controls modulation amplitude (depth), an input that controls modulation rate, plus a separate modulation wheel control for LFO depth and rate.

Each non-normed modulation input includes two parameters: modulation source (including OFF if no modulation is desired) which lets you choose from the various modulation sources mentioned above, and modulation amount.

The modulation amount can be positive or negative. With positive amounts, an increasing control signal increases the value of the parameter being controlled. With negative amounts, an increasing control signal decreases the value of the parameter being controlled. A setting of 00 is equivalent to turning off the modulation source.

Note that having two modulation inputs available allows for interaction between two modulation signals. Example: If a parameter responds to keyboard velocity and an envelope generator, the parameter will follow the general envelope shape but also be influenced by the velocity.

If a “baseline” setting exists, modulation amounts add or subtract values from that setting. Example 1: If the filter cutoff is set to a certain frequency, positive modulation amounts will increase that frequency, and negative modulation amounts will decrease that frequency. However, modulation cannot force a value beyond its maximum range. Example 2: If the filter cutoff is at the lowest possible frequency, then maximum positive modulation will vary the filter cutoff from the lowest to the highest frequency. Applying negative modulation will not affect the filter frequency because if it's at its lowest value, it cannot go any more negative.

To achieve modulation, you must first assign a source. This source can be something you physically move (Modulation Wheel, Aftertouch (pressure), Foot Pedal, Velocity (how hard you play a note), Pitch wheel, keyboard (specific notes) etc., or synthesizer parameters such as the Envelopes, LFO, Sample & Hold, Key Scalar, etc. Next, the source must be assigned to a DESTINATION (the parameter that is actually going to be modulated).

## Keyboard Scaling

Keyboard scaling allows you to set a pivot point, a note at which your keyboard splits, in order to affect one part of the keyboard differently than the other. For example:

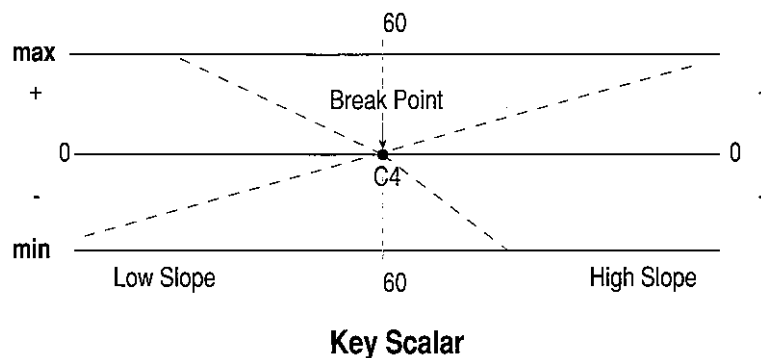

Keyboard Scaling 1 & 2 modulation sources are similar to the traditional “keyboard” modulation source, where the keyboard position (note value) increases or decreases the value accordingly. However, using the Key Scaling 1 & 2, much more control is provided. First, you can set the Break point. This defines a specific MIDI note number where the keyboard or note range is split. Notes above the break point are affected by the High Slope while notes below are affected by the Low Slope parameter. The slope parameters (High/Low) can be set to positive or negative values and affect the MODULATION destination accordingly. Remember... Key Scaling 1 & 2 are mod sources.

## Sample and Hold

Sample and Hold is an easily recognizable classic synth effect that works by creating random changes in pitch or timbre. First, up to two input sources can be selected. Both Random Noise and LFO are common settings. The waveform generated by the input source is “sampled.” The clock rate parameter determines how many “samples” are taken. At 0, the waveform is not sampled at all. The higher the value, the fewer samples are taken. The output of the Sample & Hold produces a NEW waveform created by measuring the amplitude of the input waveform at the clock pulse points (check out the graphic). The clock rate can be modulated by assigning any of the modulation sources (use the Clock Mod parameter). A clock modulation sensitivity parameter is also available which allows you to scale (+ or -) the clock rate value. Whew...got that?

Now...enter the Lag Generator.

(First, check out the graphic...) The Lag generator further alters the waveform by “smoothing” out the amplitude changes from pulse to pulse.

Again, this is a bit hard to write about, but is easy to hear. Give it a try.

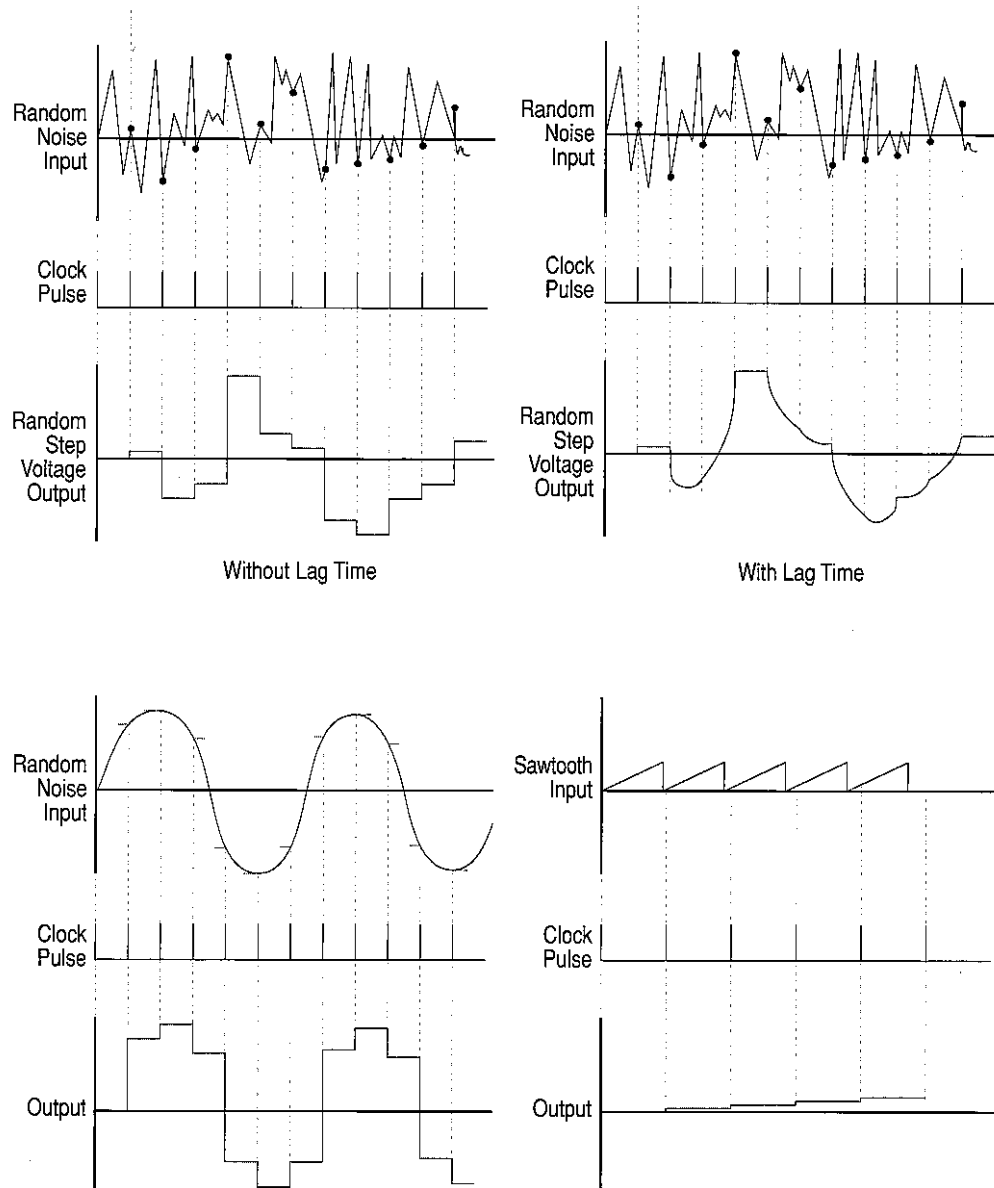

### Portamento

Portamento (also known as “glide”) is a “vintage” synth effect that allows the pitch to “glide” from one note to another. Four parameters are provided:

- Portamento on & off
- Portamento Time (0-99): The higher the setting, the slower the “glide” time between notes. A zero value is equivalent to “off.” When using a modulation source (see below), this setting becomes the “base” portamento value. Any change via modulation affects the portamento time from the base value.
- Portamento Modulation Source: Allow one of the modulation sources to control the portamento time.
- Portamento Modulation Sensitivity: Enables the modulation source to scale (+/-) the portamento value.

## Low Frequency Oscillator (LFO)

The LFO generates one of five available waveforms:

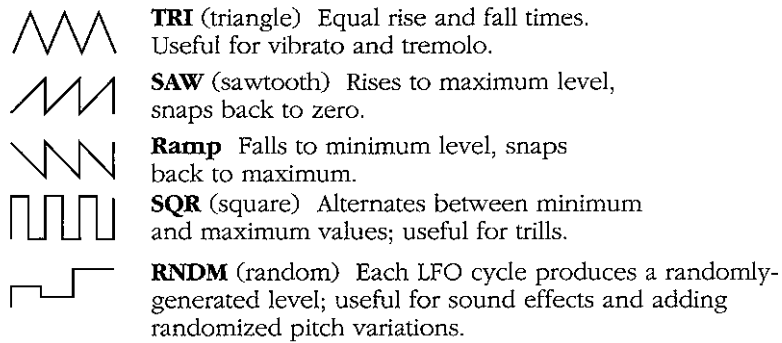

These low frequency waveforms are used to modulate (change) a destination in a repeatable manner. Most often, the LFO is used to create vibrato (modulating pitch), or tremolo (modulating amplitude).

## Envelopes

Envelopes allow some aspect of a sound to be changed over time. Along with the standard Amplitude & Filter Envelopes, two additional auxiliary envelopes are provided. Parameters include:

- Delay (the amount of time before attack begins)
- Attack (time)
- Hold (time)
- Decay (time)
- Sustain (level)
- Release (time)

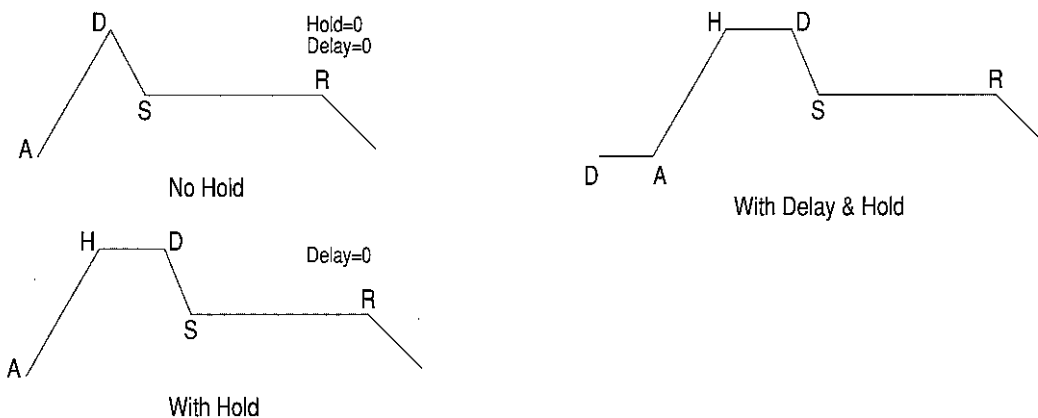

**MODULATION SOURCES/SAMPLE AND HOLD INPUT SOURCES**

<b>Mod 1 (Valid Numbers) (0-15)</b>	<b>Mod 2 (Valid Numbers) (16-31)</b>	<b>Mod Source</b>
0	16	Off
1	17	Velocity
2	18	Keyboard
3	19	Key Scaler 1
4	20	Key Scaler 2
5	21	Mod Wheel (Ctrl #1)
6	22	Pressure
7	23	Aux Env 1
8	24	Aux Env 2
9	25	LFO 1
10	26	LFO 2
11	27	Sample and Hold Output
12	28	Random
13	29	Pitch Wheel
14	30	Breath Controller (Ctrl #2)
15	31	Expression (Ctrl #11)

**WAVEFORM REFERENCE LIST**

0 Spctr1	21 MiniPluk	42 POPOV1	64 saw od4
1 Acbass 1	22 MiniSust	43 POPOV2	65 pulse od1
2 Hofbas	23 MiniLead	44 CLRFND	66 pulse od2
3 Fretless 1	24 MEMBS1	45 MM Pick	67 pulse od3
	25 MEMBS2	46 JUPITR	68 pulse od4
4 FINGBS	26 MMMUTE	47 VOCALB	69 micbass1
5 PICKBS	27 HARMONIC	48 SINE	70 micbass2
6 Fretless 2	28 M514	49 TRI	71 micbass3
7 SLAPBS		50 TRISAW	72 strat pluk
8 Acbass 2	29 M521	51 RAMP	
9 SYNBAS	30 M511	52 SAW	73 Fretless 3
10 SYNBS2	31 M512	53 SUBSAW	74 Fretless 4
11 SYNBS3	32 M821	54 SQUARE	75 Pop
12 SYNBS4	33 M821B	55 pwm1	76 PBass1
	34 M823	56 pwm2	77 PBass2
13 FM-1	35 M851	57 pwm3	
14 FM-2	36 M852	58 pwm4	
15 FM-3	37 M8B41	59 pwm5	
16 FM-4		60 pwm6	
17 FM-5	38 RBASS		
18 FM-6	39 Acbass 3	61 saw od1	
19 FM-7	40 ROUNDf	62 saw od2	
20 FM-8	41 JAZZB3	63 saw od3	



## Chapter 6      *Advanced use with a PC 1600*

When using the Bass II with a PC 1600 it is possible to create your own patches. When you create a patch it is loaded into the edit buffer overwriting whatever is there. You can create a patch by editing an existing patch or by starting from scratch.

After tweaking a patch that you like, you can save it to one of the 64 RAM locations in the Bass II (patches 0-63). To do this, select a patch number between 0 and 63 (using the front panel buttons or MIDI), select the “Bass2 Osc 1” patch on the PC1600 (first patch that was downloaded), and press button 16 on the PC1600. Now your new patch is in memory at your selected location for future use. (It remains even if the unit is powered down). The patch won't be lost unless you overwrite it with another one later, or re-init the machine. You could lose this hard earned data if your Bass II gets a spike on the AC line, or by accident if you overwrite it with something else. For this reason, we suggest that you backup your data to a MIDI storage device (like the Peavey MIDI Streamer or a computer) if you have custom patches. You can make the Bass II send its 64 RAM patches in the form of a System Exclusive dump by sending a SysEx dump request (button 15 on the PC1600's “Bass2 Osc 1” patch). If you lose your data, or have to re-init your Bass II, the data dump can be sent back to the Bass II, and it will restore the patch data automatically.

### ▼ To download the Bass II creation patches

1. Connect the MIDI Out on the Bass II to the MIDI In on the PC 1600.
2. Make sure the MIDI channel on the Bass II is set to where it will be when you edit with the PC 1600. The SysEx strings that the PC 1600 sends to the Bass II include this channel, and the Bass II won't respond if they don't match. If you change the Bass II's MIDI channel in the future, repeat this procedure to match up the two units.
3. Select the starting PC 1600 patch location on the Bass II (its patch number determines the starting destination). Since there are 24 patches to be downloaded, it is recommended that you start with patch 0 (to load the patches in locations 0-23) or 26 (to load the patches in locations 26-49).
4. Press and hold the **Transpose** button, then press the **MIDI Mode** button to download the patches. The downloading process will take a little over one minute. When the 3-digit program number comes back on the display, it's ready. (You may want to watch the PC1600's LCD during the download to make sure everything's working correctly).
5. Now reconnect the MIDI cables to their original locations. (i.e., connect the MIDI Out on the PC 1600 to the MIDI In on the Bass II.)

## Patch Editing Descriptions

### Bass 2 Osc 1

Fader 1—Wave (0-77)  
 Fader 2—Coarse Tune ( $\pm 24$ )  
 Fader 3—Fine Tune ( $\pm 99$ )  
 Fader 4—Wave Start (0-127)  
 Fader 5—Start Mod (0-15)  
 Fader 6—Start ModSns ( $\pm 99$ )  
 Fader 7—Mod Range (0-13)  
 Fader 8—Mod Source 1 (0-15)  
 Fader 9—Mod Source 2 (16-31)  
 Fader 10—Mod 1 Sns ( $\pm 99$ )  
 Fader 11—Mod 2 Sns ( $\pm 99$ )  
 Fader 12—DCA 1 Level (0-127)  
 Fader 13—DCA 1 Mod Source 1 (0-15)  
 Fader 14—DCA 1 Mod Source 2 (16-31)  
 Fader 15—DCA 1 Mod 1 Sns ( $\pm 99$ )  
 Fader 16—DCA 1 Mod 2 Sns ( $\pm 99$ )  
 Button 1—Sync On/Off  
 Button 2—Init Edit Bf  
 Button 15—Dump All  
 Button 16—Save Patch

### Bass 2 Osc 2-4

Fader 1—Wave (0-77)  
 Fader 2—Coarse Tune ( $\pm 24$ )  
 Fader 3—Fine Tune ( $\pm 99$ )  
 Fader 4—Wave Start (0-127)  
 Fader 5—Start Mod (0-15)  
 Fader 6—Start ModSns ( $\pm 99$ )  
 Fader 7—Mod Range (0-13)  
 Fader 8—Mod Source 1 (0-15)  
 Fader 9—Mod Source 2 (16-31)  
 Fader 10—Mod 1 Sns ( $\pm 99$ )  
 Fader 11—Mod 2 Sns ( $\pm 99$ )  
 Fader 12—DCA 1 Level (0-127)  
 Fader 13—DCA 1 Mod Source 1 (0-15)  
 Fader 14—DCA 1 Mod Source 2 (16-31)  
 Fader 15—DCA 1 Mod 1 Sns ( $\pm 99$ )  
 Fader 16—DCA 1 Mod 2 Sns ( $\pm 99$ )  
 Button 12—Sync On/Off (Osc 3 only)

### Bass 2 Filter/Bass II Filter 2

Fader 1—Cutoff (0-99)  
 Fader 2—Resonance (0-99)  
 Fader 3—Mod Source 1 (0-15)  
 Fader 4—Mod Source 2 (16-31)  
 Fader 5—Mod 1 Sns ( $\pm 99$ )  
 Fader 6—Mod 2 Sns ( $\pm 99$ )  
 Fader 7—Mod Source 3 (0-15)  
 Fader 8—Mod 3 Sense ( $\pm 99$ )  
 Fader 9—Res Mod Src 1 (0-2)  
 Fader 10—Res Mod Sns ( $\pm 99$ )  
 Fader 11—Filter Type (0-3)  
 Fader 12—Envelope Sensitivity ( $\pm 99$ )

### Bass 2 Mod Squad

Fader 1—KS1Brk Point (0-127)  
 Fader 2—KS1Low Slope ( $\pm 127$ )  
 Fader 3—KS1HighSlope ( $\pm 127$ )  
 Fader 4—KS2Brk Point (0-127)  
 Fader 5—KS2Low Slope ( $\pm 127$ )  
 Fader 6—KS2HighSlope ( $\pm 127$ )  
 Fader 7—Prog Pan L/R ( $\pm 99$ )  
 Fader 8—Pan Mod Src1 (0-15)  
 Fader 9—Pan Mod Src2 (16-31)  
 Fader 10—Pan Mod1 Sns ( $\pm 99$ )  
 Fader 11—Pan Mod2 Sns ( $\pm 99$ )  
 Fader 12—Porta (On/Off)  
 Fader 13—Porta-Time (0-99)  
 Fader 14—Porta-TMod 0-15  
 Fader 15—Porta-TM Sns ( $\pm 99$ )

### Bass 2 Mod Squad 2

Fader 1—Prog Pan L/R ( $\pm 99$ )  
 Fader 2—Pan Mod Src1 (0-15)  
 Fader 3—Pan Mod Src2 (16-31)  
 Fader 4—Pan Mod1 Sns ( $\pm 99$ )  
 Fader 5—Pan Mod2 Sns ( $\pm 99$ )

### Bass 2 Smpl&Hold

Fader 1—Input Src 1 (0-15)  
 Fader 2—Input Src 2 (16-31)  
 Fader 3—Clock Rate (0-99)  
 Fader 4—Clock Mod (0-15)  
 Fader 5—Clock ModSns ( $\pm 99$ )  
 Fader 6—Lag Time (0-99)  
 Fader 7—Lag Time Mod (0-15)  
 Fader 8—Time Mod Sns ( $\pm 99$ )  
 Fader 9—PseudoLog 1 ( $\pm 99$ )  
 Fader 10—PseudoLog 2 ( $\pm 99$ )

### Bass 2 LFO 1/LFO 2

Fader 1—Waveshape (0-4)  
 Fader 2—Rate (0-99)  
 Fader 3—Amount (0-99)  
 Fader 4—Fade In Time (0-99)  
 Fader 5—Delay (0-99)  
 Fader 6—Sync (0-1)  
 Fader 7—Amt MW Sns ( $\pm 99$ )  
 Fader 8—Rate MW Sns ( $\pm 99$ )  
 Fader 9—Amt Mod Src (0-15)  
 Fader 10—Amt Mod Sns ( $\pm 99$ )  
 Fader 11—Rate Mode Source (16-31)  
 Fader 12—Mod Rate Sensitivity ( $\pm 99$ )

### Bass 2 Prog Type

Fader 1—Prog Type (0-4)  
 Fader 2—Pivot Point (0-127)  
 Fader 3—Xfade/Xswtch (0-15)  
 Fader 4—Crossfade Region  $\pm 99$   
 Fader 5—Bend Range (0-24)  
 Fader 6—Legato Mode (0-2)  
     0=Front panel/MIDI cc#68  
     1=Force Legato Off  
     2=Force Legato On  
 Button 1—Solo On/Off

### Bass 2 FltrDAHDSR / Fltr2DAHDSR

Fader 1—Env Sns ( $\pm 99$ )  
 Fader 2—Delay (0-127)  
 Fader 3—Attack (0-127)  
 Fader 4—Hold (0-127)  
 Fader 5—Decay (0-127)  
 Fader 6—Sustain (0-127)  
 Fader 7—Release (0-127)

**Bass 2 FEnv Mods /  
Bass 2 FEnv2 Mods**

Fader 1—Env Sns ( $\pm 99$ )  
 Fader 2—Vel Level ( $\pm 99$ )  
 Fader 3—Kbd Level ( $\pm 99$ )  
 Fader 4—Level ModSrc (0-15)  
 Fader 5—Level ModSns ( $\pm 99$ )  
 Fader 6—Delay ModSrc (0-15)  
 Fader 7—Delay ModSns ( $\pm 99$ )  
 Fader 8—Atk ModSrc (0-15)  
 Fader 9—Atk ModSns ( $\pm 99$ )  
 Fader 10—Hld ModSrc (0-15)  
 Fader 11—Hld ModSns ( $\pm 99$ )  
 Fader 12—Decay ModSrc (0-15)  
 Fader 13—Decay ModSns ( $\pm 99$ )  
 Fader 14—Rel ModSrc (0-15)  
 Fader 15—Rel ModSns ( $\pm 99$ )

**Bass 2 AEnvDAHDSR /  
Bass 2 AEnv2DAHDSR**

Fader 1—Prog Volume (0-99)  
 Fader 2—Delay (0-127)  
 Fader 3—Attack (0-127)  
 Fader 4—Hold (0-127)  
 Fader 5—Decay (0-127)  
 Fader 6—Sustain (0-127)  
 Fader 7—Release (0-127)

**Bass 2 AEnv Mods /  
Bass 2 AEnv2 Mods**

Fader 1—Vel Level ( $\pm 127$ )  
 Fader 2—Kbd Level ( $\pm 127$ )  
 Fader 3—Level Mod Src (0-15)  
 Fader 4—Level Mod Sns ( $\pm 99$ )  
 Fader 5—Delay ModSrc (0-15)  
 Fader 6—Delay ModSns ( $\pm 99$ )  
 Fader 7—Atk Mod Src (0-15)  
 Fader 8—Atk Mod Sns ( $\pm 99$ )  
 Fader 9—Hld Mod Src (0-15)  
 Fader 10—Hld Mod Sns ( $\pm 99$ )  
 Fader 11—Decay ModSrc (0-15)  
 Fader 12—Decay ModSns ( $\pm 99$ )  
 Fader 13—Rel Mod Src (0-15)  
 Fader 14—Rel Mod Sns ( $\pm 99$ )

**Bass 2 Aux1DAHDSR /  
Bass 2 Aux2DAHDSR**

Fader 1—Delay 0-127  
 Fader 2—Attack (0-127)  
 Fader 3—Hold (0-127)  
 Fader 4—Decay (0-127)  
 Fader 5—Sustain (0-127)  
 Fader 6—Release (0-127)

**Bass 2 Aux1 Mods /  
Bass 2 Aux2 Mods**

Fader 1—Vel Level ( $\pm 127$ )  
 Fader 2—Kbd Level ( $\pm 127$ )  
 Fader 3—Level ModSrc (0-15)  
 Fader 4—Level ModSns ( $\pm 99$ )  
 Fader 5—Delay ModSrc (0-15)  
 Fader 6—Delay ModSns ( $\pm 99$ )  
 Fader 7—Atk Mod Src (0-15)  
 Fader 8—Atk Mod Sns ( $\pm 99$ )  
 Fader 9—Hld Mod Src (0-15)  
 Fader 10—Hld Mod Sns ( $\pm 99$ )  
 Fader 11—Decay ModSrc (0-15)  
 Fader 12—Decay ModSns ( $\pm 99$ )  
 Fader 13—Rel Mod Src (0-15)  
 Fader 14—Rel Mod Sns ( $\pm 99$ )

# Appendix A MIDI Implementation

## MIDI Implementation

Date: 2/96  
Version: 1.0

Model: Spectrum Bass II

Function		Transmitted*	Recognized	Remarks
Basic Channel	Default Channel	1 1-16	1 1-16	
Mode	Default Messages Altered	X X X	X X X	Set at front panel
Note Number	True Voice	0-127	24-108	
Velocity	Note On Note Off	0 X	0 0	
After-touch	Key's Ch's	X 0	X 0	Maps to any control change
Pitch Bender		0	0	
Control Change		1 - Mod Wheel 7 - Volume 10 - Pan Controller 64 - Sustain 68 - Legato Footswitch Controller 121 - Reset All Controllers 123 - All Notes Off	1 - Mod Wheel 7 - Volume 10 - Pan Controller 32 - Bank Select LSB (0,1) 64 - Sustain 68 - Legato Footswitch Controller 121 - Reset All Controllers 123 - All Notes Off	2 assignable controllers 1-119
Program Change	True#	0-127	0-127	Bank 0 = 0-127 Bank 1 = 128-255
System Exclusive		0	0	
System Common	: Song Pos : Song Sel : Tune	X X X	X X X	
System Real Time	: Clock : Commands	X X	X X	
Auxiliary Messages	: Local On/Off : All Notes Off : Active Sense : Reset	X 0 X X	X 0 X X	
* Transmitted in overflow				

Mode 1 : OMNI ON, POLY    Mode 2 : OMNI ON, MONO  
Mode 3 : OMNI OFF, POLY    Mode 4 : OMNI OFF, MONO

O : Yes  
X : No

## Appendix B Parameters Saved on Power Down

The Bass II has battery-backed memory which is used to store global parameters and user patches. The following parameters are saved on power down and recalled on power up:

- Transpose
- Fine Tune
- MIDI Mode
- MIDI Channel
- Number of Multi channels
- Autoflow Enable
- Current Program
- Multi Program Assignments
- Global Bend Range
- User patches (0-63)
- Patch Edit Buffer

Continuous controller values (including controller #7) are *not* saved.

# Appendix C System Exclusive

## SYSTEM EXCLUSIVE AND VOICE ARCHITECTURE

The Synth has a System Exclusive implementation which makes it possible to perform rudimentary patch editing for a single patch residing in the edit buffer. The contents of this edit buffer are lost on power down.

### *Spectrum Synth System Exclusive Patch Edit Command Format*

F0	System Exclusive Command
00 00 1B	Peavey System Exclusive
02	Keyboard Family I.D.
0D	Spectrum Bass II I.D.
<CH>	MIDI In Channel (00-0F)
08	Update Edit Buffer Command
<ph, pl, vh, vl>	Updates the Memory Byte at parameter offset ph, pl
F7	End of System Exclusive

**Note:** Parameter offsets are 7-bitized and values are nibblized.

#### *Example 1:*

For a desired Filter resonance value of 27 (1bh), the following string would be sent:

F0 00 00 1B 02 0D 00 08 00 23 01 0b F7

This is assuming the Synth is on MIDI channel 1. Notice how the value of 1ah is nibblized.

#### *Example 2:*

For a desired oscillator coarse tuning value of -12 (F4h), the following string would be sent:

F0 00 00 1B 02 0D 00 08 00 10 0f 04 F7

Notice that negative values are represented in two's complement.

#### *Other SysEx commands:*

Initialize Edit Buffer (to create new patch from scratch):

F0 00 00 1B 02 0D <CH> 09 F7

Save Edit Buffer to current RAM location (if 0-63):

F0 00 00 1B 02 0D <CH> 07 00 F7

Dump 64 RAM patches:

F0 00 00 1B 02 0D <CH> 01 7F F7

The following is a table of program block offsets for the Synth.

**Note:** The *offset* values are listed in **hex**, the *range* values are listed in **decimal**.

Variable Name	Offset	Description	Range
Osc1Wave	00	Osc 1 waveshape	0-77
Osc1Coarse	01	Osc 1 coarse tuning	±24
Osc1Fine	02	Osc 1 fine tuning	±99
Reserved	03	Reserved for future use	
Osc1Start	04	Sample Start point	0-127
Osc1StartMod	05	Sample Start Modulation Source	0-15
Osc1SModSens	06	Sensitivity to Start Mod. Source	±99
Reserved	07	Reserved for future use	
Osc1ModRng	08	Pitch Mod. range for Mod Source 1 & 2	0-14
Osc1Mods	09		
Osc1Mod1Sens	0A	Sensitivity to Mod source 1	±99
Osc1Mod2Sens	0B	Sensitivity to Mod source 2	±99
Dca1Level	0C	Programmed DCA 1 volume	0-99
Dca1Mods	0D	DCA 1 Mod. Source	0-15
Dca1Mod1Sens	0E	Sensitivity to Mod source 1	±99
Dca1Mod2Sens	0F	Sensitivity to Mod source 2	±99
HardSync1	10		
Osc2Wave	00	Osc 2 waveshape	0-77
Osc2Coarse	01	Osc 2 coarse tuning	±24
Osc2Fine	02	Osc 2 fine tuning	±99
Reserved	03	Reserved for future use	
Osc2Start	04	Sample Start point	0-127
Osc2StartMod	05	Sample Start Modulation Source	0-15
Osc2SModSens	06	Sensitivity to Start Mod. Source	±99
Reserved	07	Reserved for future use	
Osc2ModRng	08	Pitch Mod. range for Mod Source 1 & 2	0-14
Osc2Mods	09		
Osc2Mod1Sens	0A	Sensitivity to Mod source 1	±99
Osc2Mod2Sens	0B	Sensitivity to Mod source 2	±99
Dca2Level	0C	Programmed DCA 2 volume	0-99
Dca2Mods	0D	DCA 2 Mod. Source	0-15
Dca2Mod1Sens	0E	Sensitivity to Mod source 1	±99
Dca2Mod2Sens	0F	Sensitivity to Mod source 2	±99
Cutoff1	21	Programmed Filter cutoff frequency	0-99
Res1	22	Amount of gain at cutoff	0-99
Fil1Mods	23	Filter Mod Source 1	0-15
Fil1Mod1Sens	24	Filter Mod Source 1 Sensitivity	±99
Fil1Mod2Sens	25	Filter Mod Source 2 Sensitivity	±99
Fil1Mod3	26	Filter Mod Source 3	0-15
Fil1Mod3Sens	27	Filter Mod Source 3 Sensitivity	±99
Res1Mod	28	Res 1 Mod Source	0-2
Res1ModSens	29	Res 1 Mod Source Sensitivity	±99
Fil1Type	2A	Filter Type	0-3
Fil1EnvSens	2B	Envelope Sensitivity	±99
KbdScaler1	2C-2E		
ksBreakPt	2C	Keyboard Break Point	0-127
ksLowSlope	2D	Keyboard Scale Low Slope	±99
ksHighSlope	2E	Keyboard Scale High Slope	±99
Fil1EnvBlk	2F-43		

Variable Name	Offset	Description	Range
ADSRType	2F	Filter Type	0-3
ADSRDelay	30	Delay	0-99
ADSRAttack	31	Attack	0-99
ADSRHold	32	Hold	0-99
ADSRDecay	33	Decay	0-99
ADSRSustain	34	Sustain	0-99
ADSRRelease	35	Release	0-99
ADSRVelLev	36	Velocity Level	±99
Reserved	37	Reserved for future use	
ADSRLevMod	38	Level Mod Source	0-15
ADSRLevModSens	39	Sensitivity to Level Mod source	±99
ADSRDelayMod	3A	Delay Mod Source	0-15
ADSRDelModSens	3B	Sensitivity to Delay Mod source	±99
ADSRAttMod	3C	Attack Mod Source	0-15
ADSRAttModSens	3D	Sensitivity to Attack Mod source	±99
ADSRHoldMod	3E	Hold Mod Source	0-15
ADSRHoldModSens	3F	Sensitivity to Hold Mod source	±99
ADSRDecayMod	40	Decay Mod Source	0-15
ADSRDecModSens	41	Sensitivity to Decay Mod source	±99
ADSRReleasMod	42	Release Mod Source	0-15
ADSRRelModSens	43	Sensitivity to Release Mod source	±99
Pan1	44	Left/Right Pan	±99
Pan1Mods	45	Pan 1 Mod Source	0-15
Pan1Mod1Sens	46	Pan 1 Mod1 Source Sensitivity	±99
Pan1Mod2Sens	47	Pan 1 Mod2 Source Sensitivity	±99
Volume1	48	Patch Volume	0-99
Amp1EnvBlk	49-5D		
ADSRType	49	Filter Type	0-3
ADSRDelay	4A	Delay	0-99
ADSRAttack	4B	Attack	0-99
ADSRHold	4C	Hold	0-99
ADSRDecay	4D	Decay	0-99
ADSRSustain	4E	Sustain	0-99
ADSRRelease	4F	Release	0-99
ADSRVelLev	50	Velocity Level	±99
Reserved	51	Reserved for future use	
ADSRLevMod	52	Level Mod Source	0-15
ADSRLevModSens	53	Sensitivity to Level Mod source	±99
ADSRDelayMod	54	Delay Mod Source	0-15
ADSRDelModSens	55	Sensitivity to Delay Mod source	±99
ADSRAttMod	56	Attack Mod Source	0-15
ADSRAttModSens	57	Sensitivity to Attack Mod source	±99
ADSRHoldMod	58	Hold Mod Source	0-15
ADSRHoldModSens	59	Sensitivity to Hold Mod source	±99
ADSRDecayMod	5A	Decay Mod Source	0-15
ADSRDecModSens	5B	Sensitivity to Decay Mod source	±99
ADSRReleasMod	5C	Release Mod Source	0-15
ADSRRelModSens	5D	Sensitivity to Release Mod source	±99
AuxEnv1Blk	5E-72		
ADSRType	5E	Filter Type	0-3
ADSRDelay	5F	Delay	0-99
ADSRAttack	60	Attack	0-99



Variable Name	Offset	Description	Range
ADSRHold	61	Hold	0-99
ADSRDecay	62	Decay	0-99
ADSRSustain	63	Sustain	0-99
ADSRRelease	64	Release	0-99
ADSRVelLev	65	Velocity Level	±99
Reserved	66	Reserved for future use	
ADSRLevMod	67	Level Mod Source	0-15
ADSRLevModSens	68	Sensitivity to Level Mod source	±99
ADSRDelayMod	69	Delay Mod Source	0-15
ADSRDelModSens	6A	Sensitivity to Delay Mod source	±99
ADSRAttMod	6B	Attack Mod Source	0-15
ADSRAttModSens	6C	Sensitivity to Attack Mod source	±99
ADSRHoldMod	6D	Hold Mod Source	0-15
ADSRHoldModSens	6E	Sensitivity to Hold Mod source	±99
ADSRDecayMod	6F	Decay Mod Source	0-15
ADSRDecModSens	70	Sensitivity to Decay Mod source	±99
ADSRReleasMod	71	Release Mod Source	0-15
ADSRRelModSens	72	Sensitivity to Release Mod source	±99
AuxEnv2Blk	73-87		
ADSRType	73	Filter Type	0-3
ADSRDelay	74	Delay	0-99
ADSRAttack	75	Attack	0-99
ADSRHold	76	Hold	0-99
ADSRDecay	77	Decay	0-99
ADSRSustain	78	Sustain	0-99
ADSRRelease	79	Release	0-99
ADSRVelLev	7A	Velocity Level	±99
ADSRKbdLev	7B	Keyboard Level	±99
ADSRLevMod	7C	Level Mod Source	0-15
ADSRLevModSens	7D	Sensitivity to Level Mod source	±99
ADSRDelayMod	7E	Delay Mod Source	0-15
ADSRDelModSens	7F	Sensitivity to Delay Mod source	±99
ADSRAttMod	80	Attack Mod Source	0-15
ADSRAttModSens	81	Sensitivity to Attack Mod source	±99
ADSRHoldMod	82	Hold Mod Source	0-15
ADSRHoldModSens	83	Sensitivity to Hold Mod source	±99
ADSRDecayMod	84	Decay Mod Source	0-15
ADSRDecModSens	85	Sensitivity to Decay Mod source	±99
ADSRReleasMod	86	Release Mod Source	0-15
ADSRRelModSens	87	Sensitivity to Release Mod source	±99
Lfo1Shape	88	LFO 1 waveshape	0-7
Lfo1Rate	89	Speed of LFO1	0-99
Lfo1Amount	8A	LFO 1 Max signal level	0-99
Lfo1FadeIn	8B	LFO 1 mod fade in time	0-99
Lfo1Delay	8C	LFO 1 delay time	0-99
Lfo1Sync	8D	LFO 1 Sync	0-1
Reserved	8E	Reserved for future use	
L1AmtWhlSens	8F	Amount of mod controlled by Mod Wheel	±99
L1RateWhlSens	90	Amount of mod controlled by Rate Wheel	±99
L1Mods	91	LFO 1 Mod source	0-15
L1AmtSens	92	Sensitivity to Mod Wheel	±99
L1RateSens	93	Sensitivity to Rate Wheel	±99
Lfo2Shape	94	LFO 2 waveshape	0-7

Variable Name	Offset	Description	Range
Lfo2Rate	95	Speed of LFO 2	0-99
Lfo2Amount	96	LFO 2 Max signal level	0-99
Lfo2FadeIn	97	LFO 2 mod fade in time	0-99
Lfo2Delay	98	LFO 2 delay time	0-99
Lfo2Sync	99	LFO 2 Sync	0-1
Reserved	9A	Reserved for future use	
L2AmtWhlSens	9B	Amount of mod controlled by Mod Wheel	±99
L2RateWhlSens	9C	Amount of mod controlled by Rate Wheel	±99
L2Mods	9D	LFO 2 Mod source	0-15
L2AmtSens	9E	Sensitivity to Mod Wheel	±99
L2RateSens	9F	Sensitivity to Rate Wheel	±99
SampleHold1	A0-A8		
Input1	A0	Input 1 Source	0-15
Input2	A1	Input 2 Source	16-31
Reserved	A2	Reserved for future use	
Clk	A3	Clock Rate	0-99
ClkMod	A4	Clok Mod Source	0-15
ClkModSens	A5	Clock Mod Source Sensitivity	±99
LagTime	A6	Amount of Time before clock mod begins	0-99
LagTimeMod	A7	Lag Time Mod Source	0-15
LagTModSens	A8	Lag Time Mod Source Sensitivity	±99
ProgType	A9		
XfadeXSPivot	AA	Crossfade/CrossSwitch	
XfadeXSCtrl	AB		
XfadeRegion	AC		
PortType	AD	Portamento Type	On/Off
PortTime	AE	Portamento glide time between notes)	0-99
PortTimeMod	AF	Portamento Time Mod Source	0-15
PortTModSens	B0	Portamento Time Mod Source Sensitivity	±99
Solo Mode	B1	Solo mode (mono)	0,1
Bend Range	B2	Range of pitch wheel	0-24
Osc3Wave	B3	Osc 3 waveshape	0-77
Osc3Coarse	B4	Osc 3 coarse tuning	±24
Osc3Fine	B5	Osc 3 fine tuning	±99
Reserved	B6	Reserved for future use	
Osc3Start	B7	Sample Start point	0-127
Osc3StartMod	B8	Sample Start Modulation Source	0-15
Osc3SModSens	B9	Sensitivity to Start Mod. Source	±99
Reserved	BA	Reserved for future use	
Osc3ModRng	BB	Pitch Mod. range for Mod Source 1 & 2	0-14
Osc3Mods	BC		
Osc3Mod1Sens	BD	Sensitivity to Mod source 1	±99
Osc3Mod2Sens	BE	Sensitivity to Mod source 2	±99
Dca3Level	BF	Programmed DCA 3 volume	0-99
Dca3Mods	C0	DCA 3 Mod. Source	0-15
Dca3Mod1Sens	C1	Sensitivity to Mod source 1	±99
Dca3Mod2Sens	C2	Sensitivity to Mod source 2	±99
HardSync2	C3		

Variable Name	Offset	Description	Range
Osc4Wave	C4	Osc 4 waveshape	0-77
Osc4Coarse	C5	Osc 4 coarse tuning	±24
Osc4Fine	C6	Osc 4 fine tuning	±99
Reserved	C7	Reserved for future use	
Osc4Start	C8	Sample Start point	0-127
Osc4StartMod	C9	Sample Start Modulation Source	0-15
Osc4SModSens	CA	Sensitivity to Start Mod. Source	±99
Reserved	CB	Reserved for future use	
Osc4ModRng	CC	Pitch Mod. range for Mod Source 1 & 2	0-14
Osc4Mods	CD		
Osc4Mod1Sens	CE	Sensitivity to Mod source 1	±99
Osc4Mod2Sens	CF	Sensitivity to Mod source 2	±99
Dca4Level	D0	Programmed DCA 4 volume	0-99
Dca4Mods	D1	DCA 4 Mod. Source	0-15
Dca4Mod1Sens	D2	Sensitivity to Mod source 1	±99
Dca4Mod2Sens	D3	Sensitivity to Mod source 2	±99
Pan2	D4	Left/Right Pan	±99
Pan2Mods	D5	Pan 2 Mod Source	0-15
Pan2Mod1Sens	D6	Pan 2 Mod1 Source Sensitivity	±99
Pan2Mod2Sens	D7	Pan 2 Mod2 Source Sensitivity	±99
Cutoff2	21	Programmed Filter cutoff frequency	0-99
Res2	22	Amount of gain at cutoff	0-99
Fil2Mods	23	Filter Mod Source 1	0-15
Fil2Mod1Sens	24	Filter Mod Source 1 Sensitivity	±99
Fil2Mod2Sens	25	Filter Mod Source 2 Sensitivity	±99
Fil2Mod3	26	Filter Mod Source 3	0-15
Fil2Mod3Sens	27	Filter Mod Source 3 Sensitivity	±99
Res2Mod	28	Res 2 Mod Source	0-2
Res2ModSens	29	Res 2 Mod Source Sensitivity	±99
Fil2Type	2A	Filter Type	0-3
Fil2EnvSens	2B	Envelope Sensitivity	±99
KbdScaler2	E3-E5		
ksBreakPt	E3	Keyboard Break Point	0-127
ksLowSlope	E4	Keyboard Scale Low Slope	±99
ksHighSlope	E5	Keyboard Scale High Slope	±99
Fil2EnvBlk	E6-FA		
ADSRType	E6	Filter Type	0-3
ADSRDelay	E7	Delay	0-99
ADSRAttack	E8	Attack	0-99
ADSRHold	E9	Hold	0-99
ADSRDecay	EA	Decay	0-99
ADSRSustain	EB	Sustain	0-99
ADSRRelease	EC	Release	0-99
ADSRVelLev	ED	Velocity Level	±99
ADSRKbdLev	EE	Keyboard Level	±99
ADSRLevMod	EF	Level Mod Source	0-15
ADSRLevModSens	F0	Sensitivity to Level Mod source	±99
ADSRDelayMod	F1	Delay Mod Source	0-15
ADSRDelModSens	F2	Sensitivity to Delay Mod source	±99
ADSRAttMod	F3	Attack Mod Source	0-15
ADSRAttModSens	F4	Sensitivity to Attack Mod source	±99

Variable Name	Offset	Description	Range
ADSRHoldMod	F5	Hold Mod Source	0-15
ADSRHoldModSens	F6	Sensitivity to Hold Mod source	±99
ADSRDecayMod	F7	Decay Mod Source	0-15
ADSRDecModSens	F8	Sensitivity to Decay Mod source	±99
ADSRReleasMod	F9	Release Mod Source	0-15
ADSRRelModSens	FA	Sensitivity to Release Mod source	±99
Volume2	FB	Patch Volume	0-99
Amp2EnvBlk	FC-110		
ADSRType	FC	Filter Type	0-3
ADSRDelay	FD	Delay	0-99
ADSRAttack	FE	Attack	0-99
ADSRHold	FF	Hold	0-99
ADSRDecay	100	Decay	0-99
ADSRSustain	101	Sustain	0-99
ADSRRelease	102	Release	0-99
ADSRVelLev	103	Velocity Level	±99
Reserved	03	Reserved for future use	
ADSRLevMod	105	Level Mod Source	0-15
ADSRLevModSens	106	Sensitivity to Level Mod source	±99
ADSRDelayMod	107	Delay Mod Source	0-15
ADSRDelModSens	108	Sensitivity to Delay Mod source	±99
ADSRAttMod	109	Attack Mod Source	0-15
ADSRAttModSens	10A	Sensitivity to Attack Mod source	±99
ADSRHoldMod	10B	Hold Mod Source	0-15
ADSRHoldModSens	10C	Sensitivity to Hold Mod source	±99
ADSRDecayMod	10D	Decay Mod Source	0-15
ADSRDecModSens	10E	Sensitivity to Decay Mod source	±99
ADSRReleasMod	10F	Release Mod Source	0-15
ADSRRelModSens	110	Sensitivity to Release Mod source	±99
LegatoInit	111	Legato status upon recall	0-2, 0= Front panel/MIDI 1= Force legato Off 2= Force legato On
Reserved Block Size = 14A (330 bytes)	112-149	Reserved for future use	

## **BANK SELECT MESSAGES**

The Bank Select message has been defined by the MIDI Manufacturers Association to consist of control change numbers 00h and 20h as shown below:

B <i>n</i> h	Control change status byte on channel <i>n+1</i>
00h	Bank Select (MSB)
0vvvvvvv	MSB (zeros for the Spectrum Bass II)
20h	Bank Select (LSB)
0vvvvvvv	LSB (zero or one for the Spectrum Bass II)
C <i>n</i> h	Program Change on channel <i>n+1</i>
0ppppppp	Program Number (0-127)

Note that the Bank Select message **must** be followed by a Program Change message.

*Example 1:* The Spectrum Bass II will move to the program 26 in bank 1 (prog. #154; 128 + 26) if the following string is sent:

B0 00 00 20 01 C0 1a

*Example 2:* The Spectrum Synth (on MIDI Channel 16) will move to program 26 in bank 0 (zero) if the following string is sent:

Bf 00 00 20 00 Cf 1a

**THIS LIMITED WARRANTY VALID ONLY WHEN PURCHASED AND REGISTERED IN THE UNITED STATES OR CANADA. ALL EXPORTED PRODUCTS ARE SUBJECT TO WARRANTY AND SERVICES TO BE SPECIFIED AND PROVIDED BY THE AUTHORIZED DISTRIBUTOR FOR EACH COUNTRY.**  
**Ces clauses de garantie ne sont valables qu'aux Etats-Unis et au Canada. Dans tout les autres pays, les clauses de garantie et de maintenance sont fixees par le distributeur national et assuree par lui selon la legislation en vigueur.**  
**Diese Garantie ist nur in den USA und Kanada gultig. Alle Export-Produkte sind der Garantie und dem Service des Importeurs des jeweiligen Landes unterworfen. Esta garantia es valida solamente cuando el producto es comprado en E.U. continentales o en Canada. Todos los productos que sean comprados en el extranjero, estan sujetos a las garantias y servicio que cada distribuidor autorizado determine y ofrezca en los diferentes paises.**

**PEAVEY ONE-YEAR LIMITED  
WARRANTY/REMEDY**

PEAVEY ELECTRONICS CORPORATION ("PEAVEY") warrants this product, EXCEPT for covers, footswitches, patchcords, tubes and meters, to be free from defects in material and workmanship for a period of one (1) year from date of purchase, PROVIDED, however, that this limited warranty is extended only to the original retail purchaser and is subject to the conditions, exclusions, and limitations hereinafter set forth:

**PEAVEY 90-DAY LIMITED WARRANTY ON TUBES AND METERS**

If this product contains tubes or meters, Peavey warrants the tubes or meters contained in the product to be free from defects in material and workmanship for a period of ninety (90) days from date of purchase; PROVIDED, however, that this limited warranty is extended only to the original retail purchaser and is also subject to the conditions, exclusions, and limitations hereinafter set forth.

**CONDITIONS, EXCLUSIONS, AND LIMITATIONS OF LIMITED WARRANTIES**

These limited warranties shall be void and of no effect, if:

- a. The first purchase of the product is for the purpose of resale; or
- b. The original retail purchase is not made from an AUTHORIZED PEAVEY DEALER; or
- c. The product has been damaged by accident or unreasonable use, neglect, improper service or maintenance, or other causes not arising out of defects in material or workmanship; or
- d. The serial number affixed to the product is altered, defaced, or removed.

In the event of a defect in material and/or workmanship covered by this limited warranty, Peavey will:

- a. In the case of tubes or meters, replace the defective component without charge.
- b. In other covered cases (i.e., cases involving anything other than covers, footswitches, patchcords, tubes or meters), repair the defect in material or workmanship or replace the product, at Peavey's option; and provided, however, that, in any case, all costs of shipping, if necessary, are paid by you, the purchaser.

**THE WARRANTY REGISTRATION CARD SHOULD BE ACCURATELY COMPLETED AND MAILED TO AND RECEIVED BY PEAVEY WITHIN FOURTEEN (14) DAYS FROM THE DATE OF YOUR PURCHASE.**

In order to obtain service under these warranties, you must:

- a. Bring the defective item to any PEAVEY AUTHORIZED DEALER or AUTHORIZED PEAVEY SERVICE CENTER and present therewith the ORIGINAL PROOF OF PURCHASE supplied to you by the AUTHORIZED PEAVEY DEALER in connection with your purchase from him of this product.

If the DEALER or SERVICE CENTER is unable to provide the necessary warranty service you will be directed to the nearest other PEAVEY AUTHORIZED DEALER or AUTHORIZED PEAVEY SERVICE CENTER which can provide such service.

**OR**

- b. Ship the defective item, prepaid, to:

PEAVEY ELECTRONICS CORPORATION  
International Service Center  
326 Hwy. 11 & 80 East  
MERIDIAN, MS 39301

including therewith a complete, detailed description of the problem, together with a legible copy of the original PROOF OF PURCHASE and a complete return address. Upon Peavey's receipt of these items:

If the defect is remedial under these limited warranties and the other terms and conditions expressed herein have been complied with, Peavey will provide the necessary warranty service to repair or replace the product and will return it, FREIGHT COLLECT, to you, the purchaser.

Peavey's liability to the purchaser for damages from any cause whatsoever and regardless of the form of action, including negligence, is limited to the actual damages up to the greater of \$500.00 or an amount equal to the purchase price of the product that caused the damage or that is the subject of or is directly related to the cause of action. Such purchase price will be that in effect for the specific product when the cause of action arose. This limitation of liability will not apply to claims for personal injury or damage to real property or tangible personal property allegedly caused by Peavey's negligence. Peavey does not assume liability for personal injury or property damage arising out of or caused by a non-Peavey alteration or attachment, nor does Peavey assume any responsibility for damage to interconnected non-Peavey equipment that may result from the normal functioning and maintenance of the Peavey equipment.

**UNDER NO CIRCUMSTANCES WILL PEAVEY BE LIABLE FOR ANY LOST PROFITS, LOST SAVINGS, ANY INCIDENTAL DAMAGES, OR ANY CONSEQUENTIAL DAMAGES ARISING OUT OF THE USE OR INABILITY TO USE THE PRODUCT, EVEN IF PEAVEY HAS BEEN ADVISED OF THE POSSIBILITY OF SUCH DAMAGES.**

THESE LIMITED WARRANTIES ARE IN LIEU OF ANY AND ALL WARRANTIES, EXPRESSED OR IMPLIED, INCLUDING, BUT NOT LIMITED TO, THE IMPLIED WARRANTIES OF MERCHANTABILITY AND FITNESS FOR A PARTICULAR USE; PROVIDED, HOWEVER, THAT IF THE OTHER TERMS AND CONDITIONS NECESSARY TO THE EXISTENCE OF THE EXPRESSED, LIMITED WARRANTIES, AS HEREINABOVE STATED, HAVE BEEN COMPLIED WITH, IMPLIED WARRANTIES ARE NOT DISCLAIMED DURING THE APPLICABLE ONE-YEAR OR NINETY-DAY PERIOD FROM DATE OF PURCHASE OF THIS PRODUCT.

SOME STATES DO NOT ALLOW LIMITATION ON HOW LONG AN IMPLIED WARRANTY LASTS, OR THE EXCLUSION OR LIMITATION OF INCIDENTAL OR CONSEQUENTIAL DAMAGES, SO THE ABOVE LIMITATIONS OR EXCLUSIONS MAY NOT APPLY TO YOU. THESE LIMITED WARRANTIES GIVE YOU SPECIFIC LEGAL RIGHTS, AND YOU MAY ALSO HAVE OTHER RIGHTS WHICH MAY VARY FROM STATE TO STATE.

THESE LIMITED WARRANTIES ARE THE ONLY EXPRESSED WARRANTIES ON THIS PRODUCT, AND NO OTHER STATEMENT, REPRESENTATION, WARRANTY, OR AGREEMENT BY ANY PERSON SHALL BE VALID OR BINDING UPON PEAVEY.

In the event of any modification or disclaimer of expressed or implied warranties, or any limitation of remedies, contained herein conflicts with applicable law, then such modification, disclaimer or limitation, as the case may be, shall be deemed to be modified to the extent necessary to comply with such law.

Your remedies for breach of these warranties are limited to those remedies provided herein and Peavey Electronics Corporation gives this limited warranty only with respect to equipment purchased in the United States of America.

**INSTRUCTIONS — WARRANTY REGISTRATION CARD**

1. Mail the completed WARRANTY REGISTRATION CARD to:

PEAVEY ELECTRONICS CORPORATION  
POST OFFICE BOX 2898  
MERIDIAN, MISSISSIPPI 39302-2898

- a. Keep the PROOF OF PURCHASE. In the event warranty service is required during the warranty period, you will need this document. There will be no identification card issued by Peavey Electronics Corporation.
2. IMPORTANCE OF WARRANTY REGISTRATION CARDS AND NOTIFICATION OF CHANGES OF ADDRESSES:
  - a. Completion and mailing of WARRANTY REGISTRATION CARDS — Should notification become necessary for any condition that may require correction, the REGISTRATION CARD will help ensure that you are contacted and properly notified.
  - b. Notice of address changes — If you move from the address shown on the WARRANTY REGISTRATION CARD, you should notify Peavey of the change of address so as to facilitate your receipt of any bulletins or other forms of notification which may become necessary in connection with any condition that may require dissemination of information or correction.
3. You may contact Peavey directly by telephoning (601) 483-5365.

## IMPORTANT SAFETY INSTRUCTIONS

**WARNING:** When using electric products, basic cautions should always be followed, including the following.

1. Read all safety and operating instructions before using this product.
2. All safety and operating instructions should be retained for future reference.
3. Obey all cautions in the operating instructions and on the back of the unit.
4. All operating instructions should be followed.
5. This product should not be used near water, i.e., a bathtub, sink, swimming pool, wet basement, etc.
6. This product should be located so that its position does not interfere with its proper ventilation. It should not be placed flat against a wall or placed in a built-in enclosure that will impede the flow of cooling air.
7. This product should not be placed near a source of heat such as a stove, radiator, or another heat producing amplifier.
8. Connect only to a power supply of the type marked on the unit adjacent to the power supply cord.
9. Never break off the ground pin on the power supply cord. For more information on grounding, write for our free booklet "Shock Hazard and Grounding."
10. Power supply cords should always be handled carefully. Never walk or place equipment on power supply cords. Periodically check cords for cuts or signs of stress, especially at the plug and the point where the cord exits the unit.
11. The power supply cord should be unplugged when the unit is to be unused for long periods of time.
12. If this product is to be mounted in an equipment rack, rear support should be provided.
13. Metal parts can be cleaned with a damp rag. The vinyl covering used on some units can be cleaned with a damp rag or an ammonia-based household cleaner if necessary. Disconnect unit from power supply before cleaning.
14. Care should be taken so that objects do not fall and liquids are not spilled into the unit through the ventilation holes or any other openings.
15. This unit should be checked by a qualified service technician if:
  - a. The power supply cord or plug has been damaged.
  - b. Anything has fallen or been spilled into the unit.
  - c. The unit does not operate correctly.
  - d. The unit has been dropped or the enclosure damaged.
16. The user should not attempt to service this equipment. All service work should be done by a qualified service technician.
17. This product should be used only with a cart or stand that is recommended by Peavey Electronics.
18. Exposure to extremely high noise levels may cause a permanent hearing loss. Individuals vary considerably in susceptibility to noise induced hearing loss, but nearly everyone will lose some hearing if exposed to sufficiently intense noise for a sufficient time.

The U.S. Government's Occupational Safety and Health Administration (OSHA) has specified the following permissible noise level exposures.

Duration Per Day In Hours	Sound Level dBA, Slow Response
8	90
6	92
4	95
3	97
2	100
1 1/2	102
1	105
1/2	110
1/4 or less	115

ΩAccording to OSHA, any exposure in excess of the above permissible limits could result in some hearing loss.

Ear plugs or protectors in the ear canals or over the ears must be worn when operating this amplification system in order to prevent a permanent hearing loss if exposure is in excess of the limits as set forth above. To ensure against potentially dangerous exposure to high sound pressure levels, it is recommended that all persons exposed to equipment capable of producing high sound pressure levels such as this amplification system be protected by hearing protectors while this unit is in operation.

**SAVE THESE INSTRUCTIONS!**